

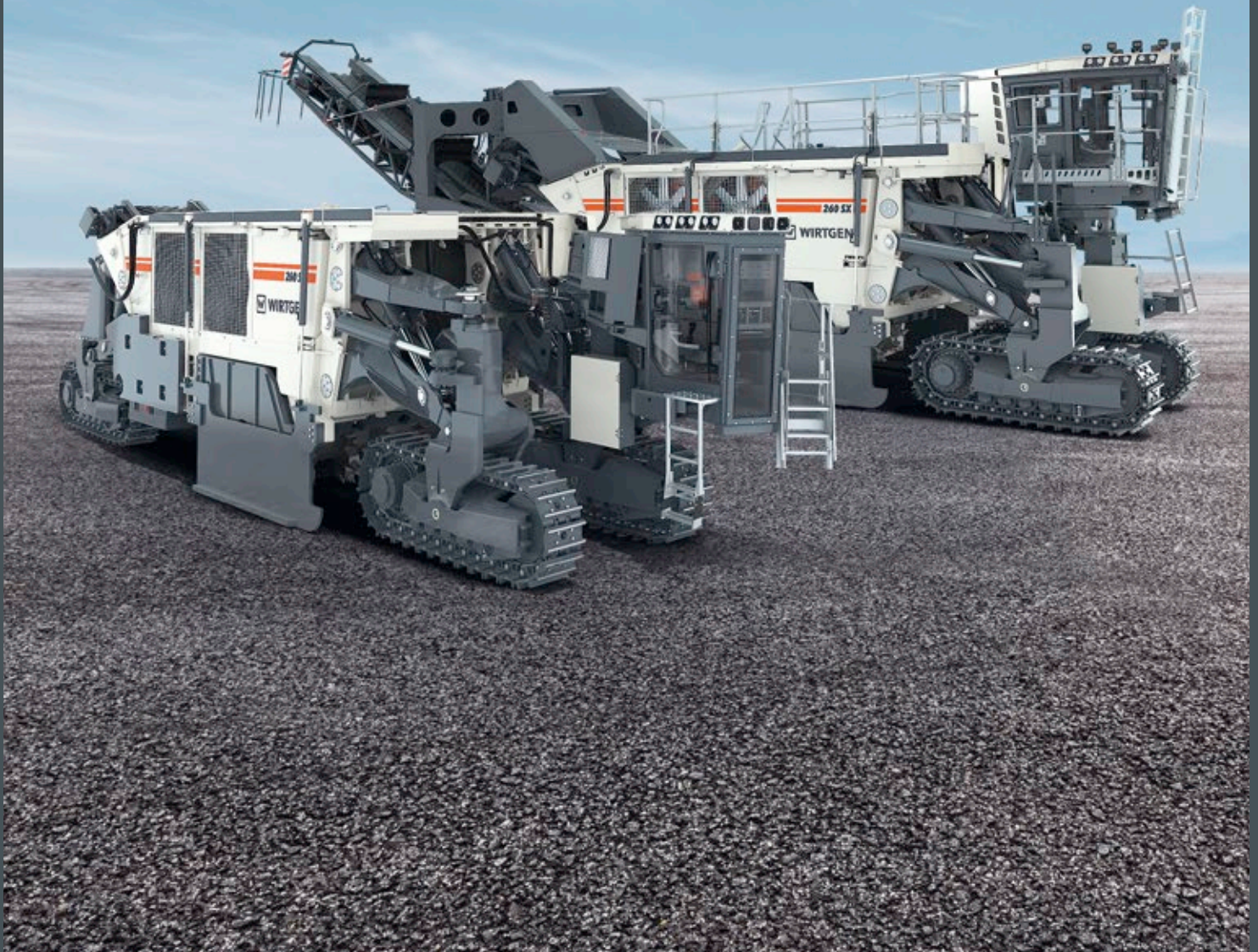

Technology and Performance for the Most Challenging Infrastructure Projects

CROSS APPLICATION MINER 260 SX(i)



TECHNOLOGY AND PERFORMANCE FOR THE MOST CHALLENGING INFRASTRUCTURE PROJECTS

The 260 SX(i) cross application miner provides solutions for the most challenging infrastructure projects and impresses with maximum utilization rates and highest daily productivity.

Its fields of application include routing work for the construction of roads and railroads, the construction of harbor basins and pipelines, and projects in tunnels.

Its 2750 mm cutting drum with a cutting depth of up to 650 mm offers high cutting performance rates and optimum material flow with lowest possible pick wear

The compact machine features a short, height-adjustable and slewing rear discharge conveyor for loading trucks in the tightest spaces and, by removing the discharge conveyor and superstructure, can be made even lower for special applications in tunnels.

Depending on the application, its all-round glazed, air-conditioned, and soundproofed operator's cabin can be mounted either at the top or the bottom of the front left chassis column.





WIRTGEN CROSS APPLICATION MINER



60-TON CLASS

- > Cutting width up to 3,800 mm
- > Cutting depth up to 350 mm



120-TON CLASS

- > Cutting width up to 2,750 mm
- > Cutting depth up to 650 mm



200-TON CLASS

- > Cutting width up to 4,200 mm
- > Cutting depth up to 830 mm



WHAT IS A CROSS APPLICATION MINER?

WIRTGEN High-Performance Machines Clear the Way

There - in rocky terrain - where excavators with hydraulic hammers find the going hard, or face months of laborious, costly, and deafeningly noisy work, is where cross application miners come into their own and literally chew their way through stone and solid rock. Cross Application Miner Cutting, crushing and loading of material in a single operation. The process is almost vibration-free and causes only very little dust and noise pollution. The immensely powerful machines are particularly versatile. For example, they are used on demanding infrastructure projects, for cutting road and rail routes, lowering tunnel floors, and in the construction of harbors or water retention basins.

With the aid of unique WIRTGEN cutting technology and sophisticated WIRTGEN leveling systems, the machines cut precisely leveled profiles to predefined depths. Routes cut in this way serve as an ideal foundation for base courses and bed-

ding layers. At the same time, transport vehicles can drive on the even surface throughout the course of the construction project without causing damage, and the material removed can often be reused in-place.

In most cases, the material removed is loaded into street-legal dump trucks with the machine's integrated discharge conveyor. Aside from performance, and as infrastructure projects often have to fulfill critical deadlines, a particular focus in the construction of these machines was set on assuring high machine utilization rates. In view of their frequently changing assignments, cross application miners are also designed to be easier to move from site to site than classic mining equipment.



01 Cross application miners are purpose-built for frequently changing applications, particularly in the course of larger infrastructure projects.

02 If required on a job, the material removed can also be conveniently reused as an aggregate.

03 The material removed can be loaded directly into street-legal dump trucks with the machine's integrated discharge conveyor.

04 Hard rock can be efficiently cut and removed without the need for drilling and explosives, even in the vicinity of residential areas, public roads, or other existing infrastructure.

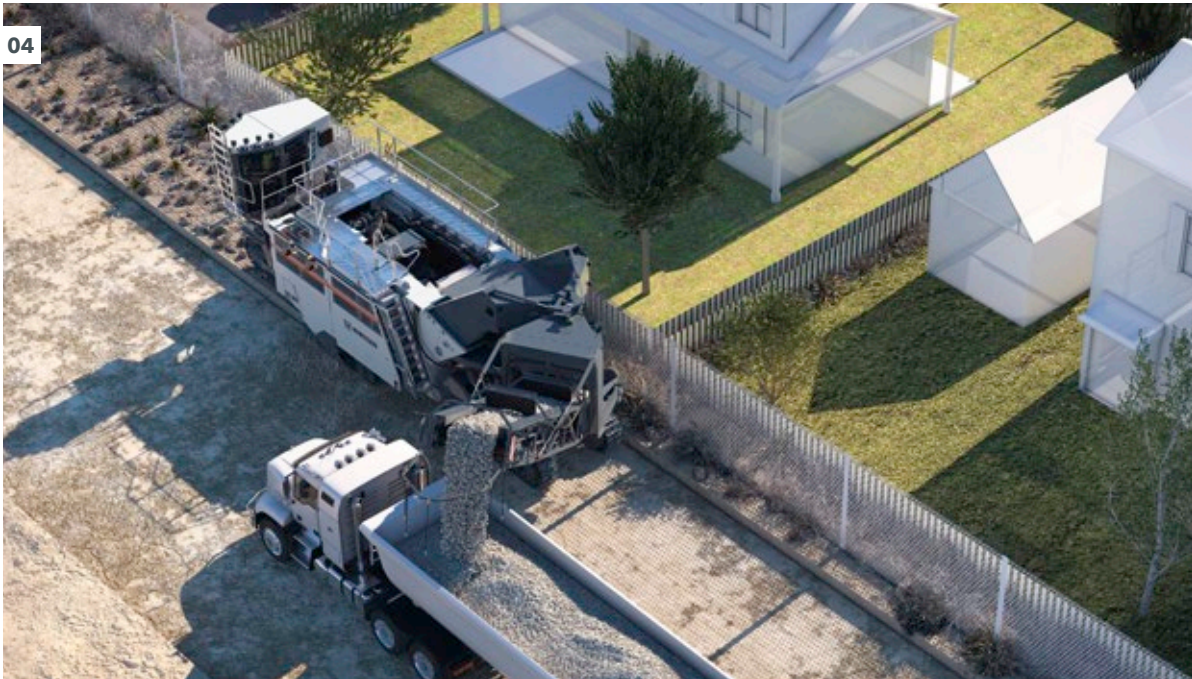

EXTREME VERSATILITY FOR INFRA-STRUCTURE CONSTRUCTION PROJECTS

Whether for routing operations for railroad projects, pipeline laying, the construction of roads, tunnels, harbors, or water retention basins - the 260 SX(i) cross application miner is the ideal choice for an extremely broad spectrum of applications.

It cuts and crushes all types of stone and rock and loads them into dump trucks or deposits them in heaps behind or alongside the machine, all in one pass.



01

- 01 Routing for Road and Railroad Infrastructure.
- 02 Cutting of irrigation and drainage channels.
- 03 Construction and straightening of access and transit roads.

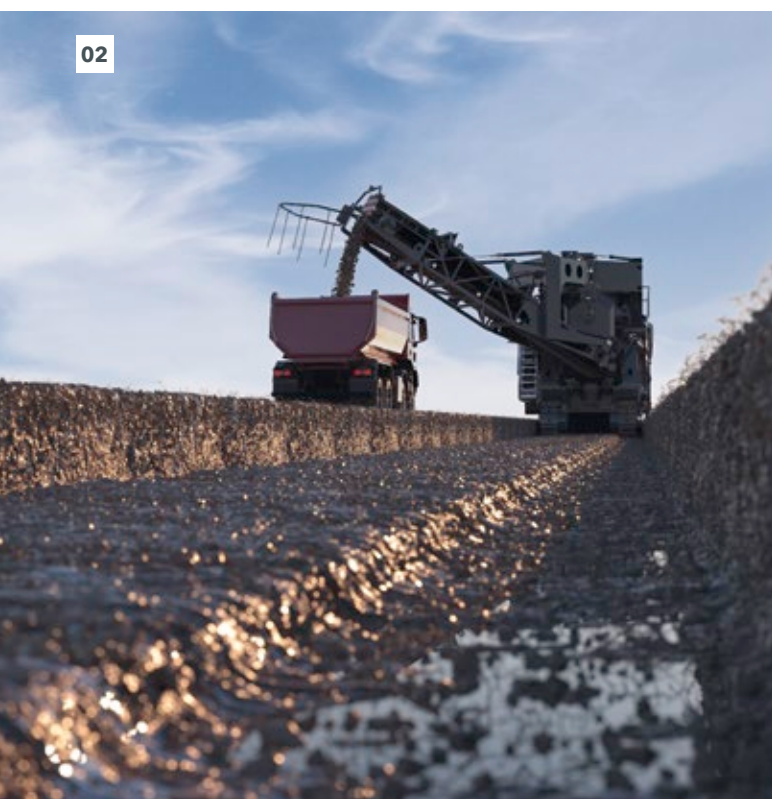

02

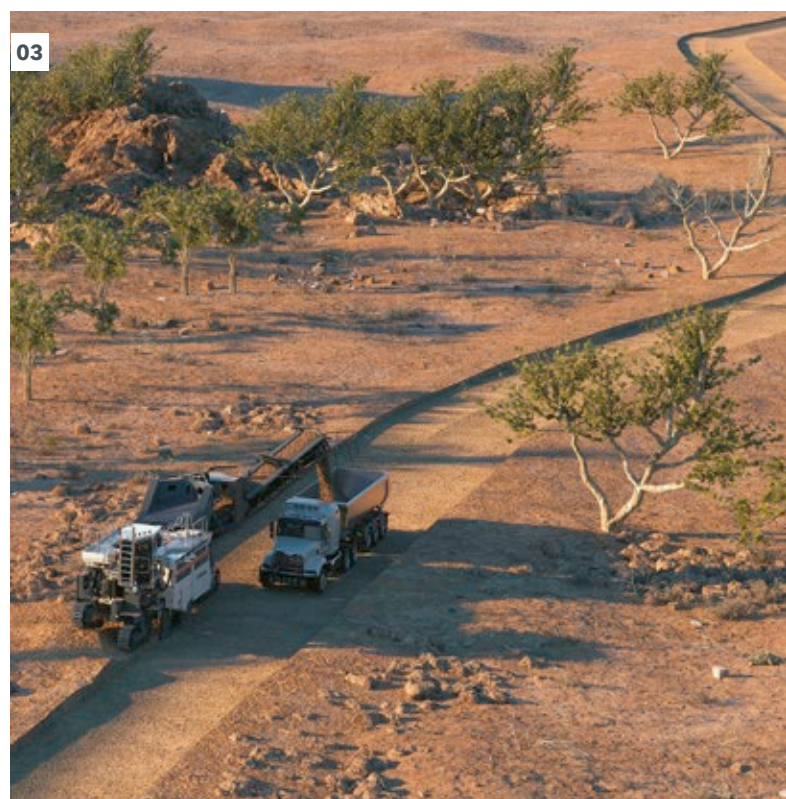

03



04 Excavation of harbor basins.



05 Trenching for pipelines.

06 Profiling and lowering of tunnel floors.



DETAILS OF TUNNEL CONSTRUCTION

01 The compact dimensions of the machine in its tunnel construction configuration enable efficient working in the confined spaces.

The construction of new tunnels or the lowering of the floors of existing tunnels often involves working in confined spaces and during ongoing rail traffic. Blasting is rarely a viable option for loosening the rock. The cross application miner enables the precise construction of trackbeds with minimal vibration and the lowering of the tunnel profiles to a specified level.

The height of the miner can be reduced to less than 3.5 meters for working in tunnels by mounting the operator's cabin directly above the front left track unit. In this configuration, the machine also works using the cut-to-ground method, without a discharge conveyor and conveyor frame. This means that the 260 SX(i) can also realize its full performance potential in narrow tunnel systems.

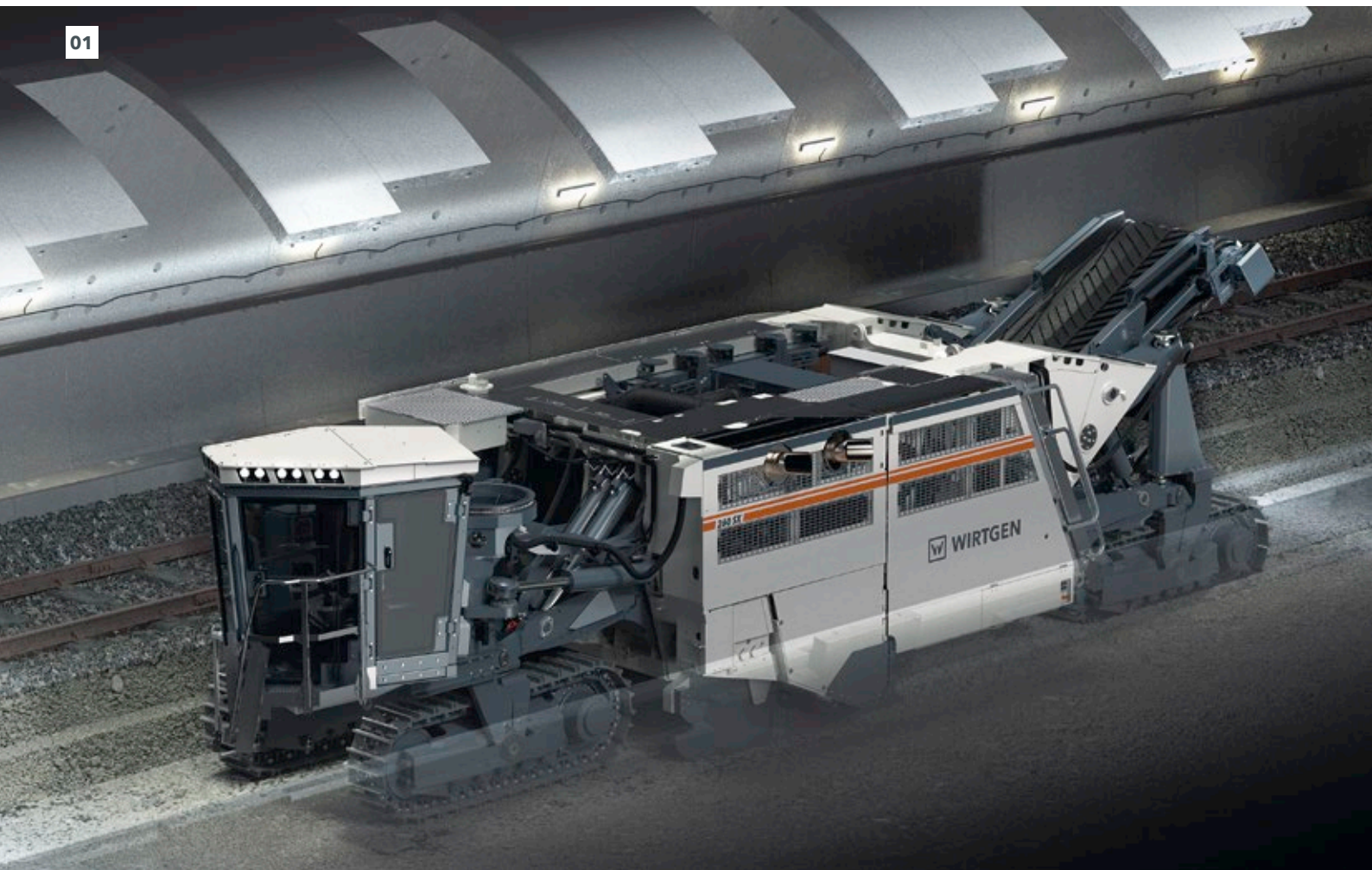

Low Cabin Position, Shallow Conveyor Angle

Adapted dimensions



02

02 The 260 SX (i) continuously deposits the material removed by the cut-to-ground method.

03 The outer profile is automatically realized by layer-by-layer removal of the bench until the desired depth is reached.

04 The lowering of tunnel floors enables the realization of modern, higher-capacity rail transport systems.

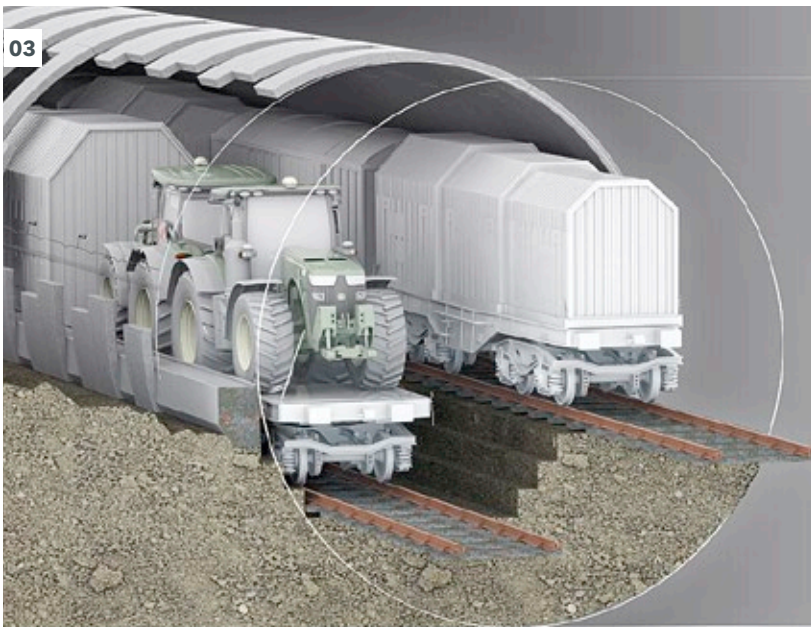

03

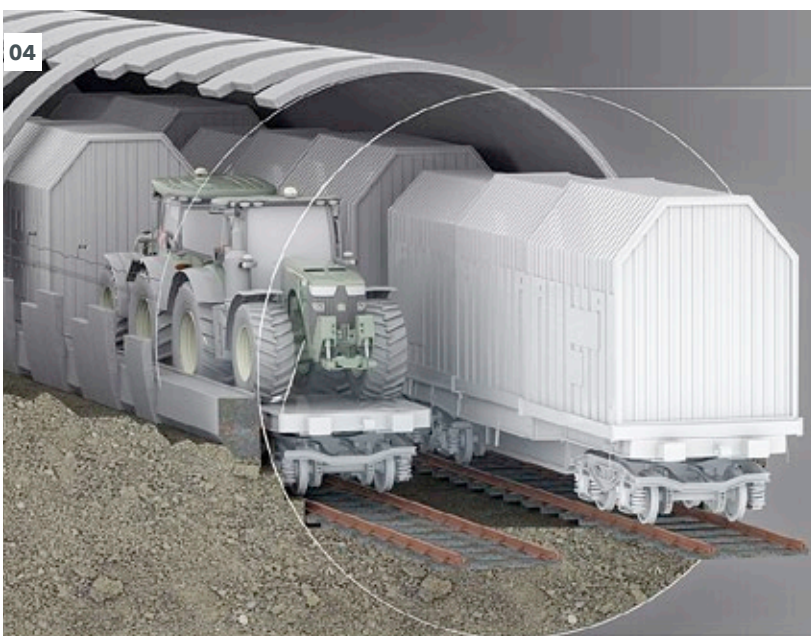
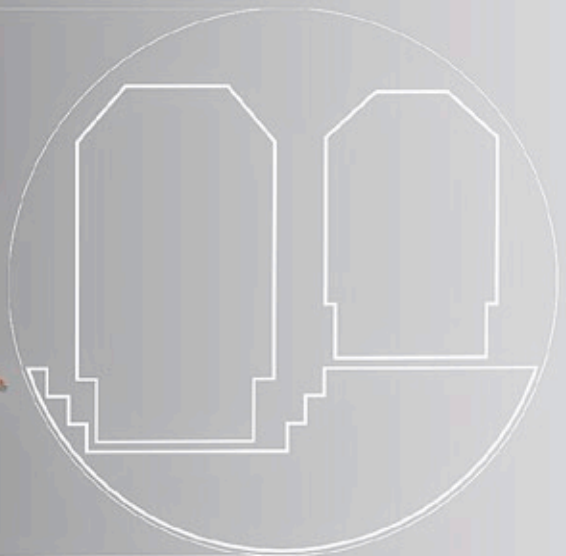

04

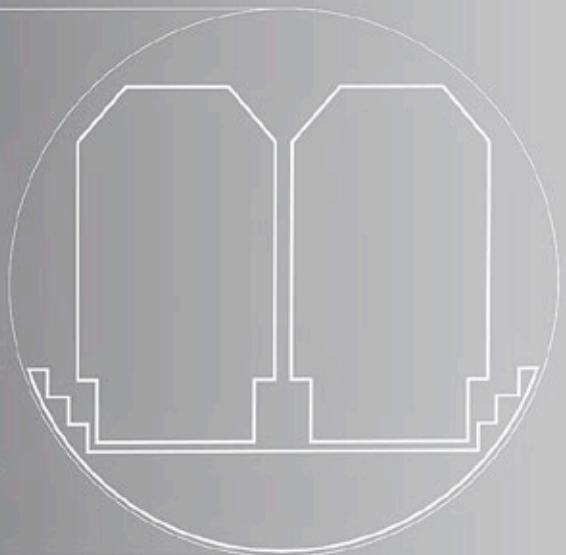

OVERVIEW OF HIGHLIGHTS

Powerful, versatile, reliable - developed for challenging infrastructure projects

01 Maximum Reliability and Utilization Rates

- > 30.5-liter diesel engine with long-life service components
- > Robust, modular CAN bus system, in part with dual-channel signal transmission
- > Balanced load distribution on the track units thanks to the machine's optimized center of gravity

04 Advanced Engine Technology

- > Variable cooler fan control for optimum power utilization and low fuel consumption
- > Powerful diesel engine with high maximum torque, compliant with US EPA Tier 2 + US EPA Tier 4f / EU Stage 5 exhaust emission standards
- > Efficient engine control system for low fuel consumption and minimal exhaust gas and noise emissions

02 Highly Efficient Cutting Technology

- > Wear-resistant pick holder systems for optimal pick service life when cutting in all types of rock
- > Soft rock cutting drum unit for minimized resistance in the drum housing and optimal material flow
- > Hard rock cutting drum unit for maximum durability in hard rocks

03 High Productivity

- > Short, compact, conveyor system for working in confined spaces
- > High machine utilization rates for maximum daily output
- > Water tank capacity of 3,300 l for long working periods
- > Six cutting drum speed settings

05 Smart Maintenance Concept

- > Direct access to all service and maintenance points
- > On-board computer displays service reminders, error messages and diagnostics functions in plain text



06 Effective Safety Concept

- > Dust-sealed pressurized cabin and fresh air filtration effectively prevent the ingress of dust into the operator's workplace.
- > Comprehensive machine lighting with LED floodlights for the working area, discharge conveyor lights, and illuminated access ladders and walkways
- > Cabin with operator's seat and built-in, certified ROPS / FOPS set-up and a trainer's seat for safe, on the job operator training

07

High Operator-Comfort - Perfect Ergonomics

- > Rotatable cabin and a camera/monitor system with six cameras improve all-round vision and make the operator's work much easier
- > Operating concept based on the latest ergonomic standards for hours of fatigue-free work
- > Operator's cabin mounted on the front left chassis column and decoupled from the machine body

08 Optimal Advance & Fast Turning

- > Four steering modes and separately steerable rear axle
- > Hydraulic all-track steering with Ackermann steering system enables a turning circle of less than nine meters
- > Automatic parallel to surface leveling

09 Precision Leveling with LEVEL PRO ACTIVE

- > **LEVEL PRO ACTIVE** leveling system integrated in the on-board computer
- > Interface for all commonly used 3D machine control systems
- > Manual floating position of side plate lifting cylinders

10 Environmentally Compatible Machine Technology

- > Efficient water management with automatic functions
- > Enclosed material transfer point on the conveyor unit reduces dust emissions
- > Sealed cutting drum housing keeps surfaces behind the machine clean

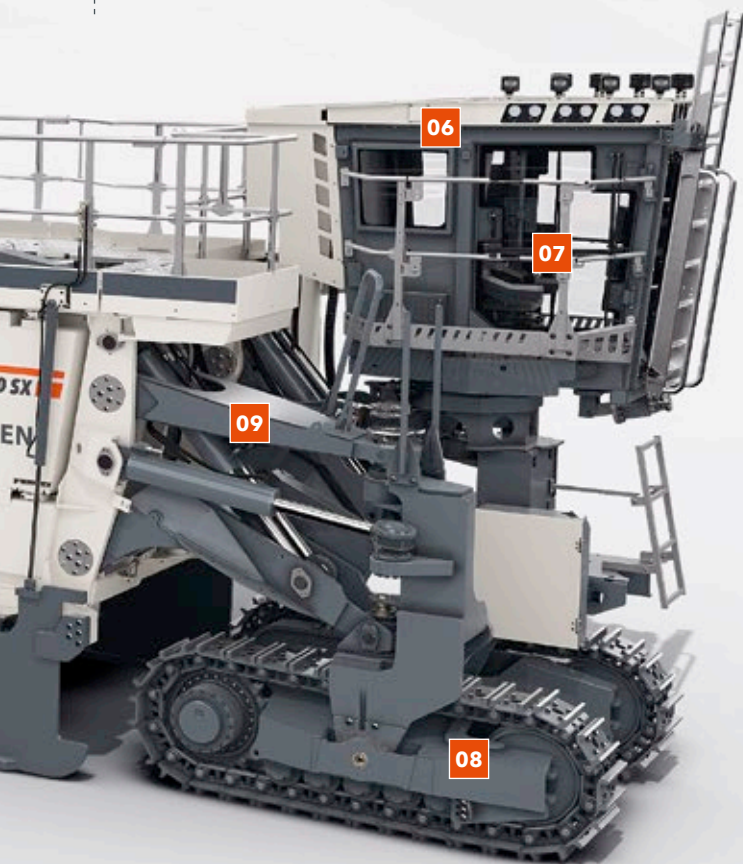

Tunneling Variant



Compact and Efficient

- > Reduction of machine height enables deployment in tunnels
- > Operator's cabin mounted immediately above the front left track unit
- > No discharge conveyor and conveyor frame - material removal by "cut-to-ground" method



HIGH MACHINE UTILIZATION RATE FOR MAXIMUM DAILY PRODUCTIVITY



Efficient Machine Utilization

Cross Application Miner present the ideal solution for cost-efficient cutting of rock and stone with a variety of hardnesses in the course of infrastructure projects. This is because the high-performance machines with a center of gravity directly above the cutting drum are distinguished by the extremely robust engineering of their components, e.g. an extra-short, slewing discharge conveyor, enormous operating weight, powerful engine technology, optimal transportability, and easy maintenance. Together, all these factors guarantee consistently high daily productivity on every job - with simultaneously high machine utilization rates and long service life. At the same time, the comfort cabin is a low-fatigue and ergonomic workplace for the machine operator, especially when working long shifts. This optimizes productivity and enables the consistent delivery of highest quality results.

Diesel Engine with Long-Life Service Components

The 260 SX(i) is ideally equipped for the tough conditions encountered on a wide range of infrastructure projects. Components that are built to last - for example a 30.5-liter diesel engine with long-life service components, a ruggedly constructed cutting drum unit, and an extremely efficient discharge conveyor - all combined and mounted as a powerful



and efficient unit on a high-tech chassis engineered to guarantee an extremely long service life.

Robust Electrical Concept with CAN Bus Reserve Lines

If the need arises, the CAN bus can be flexibly reconnected via the reserve lines. The most important controls are equipped with two-channel signal transmission to ensure that functions will still be carried out in the event of signal failure on one of the channels. In the event of a signal failure, the operator is also notified by an error message in plain text on the display screen.

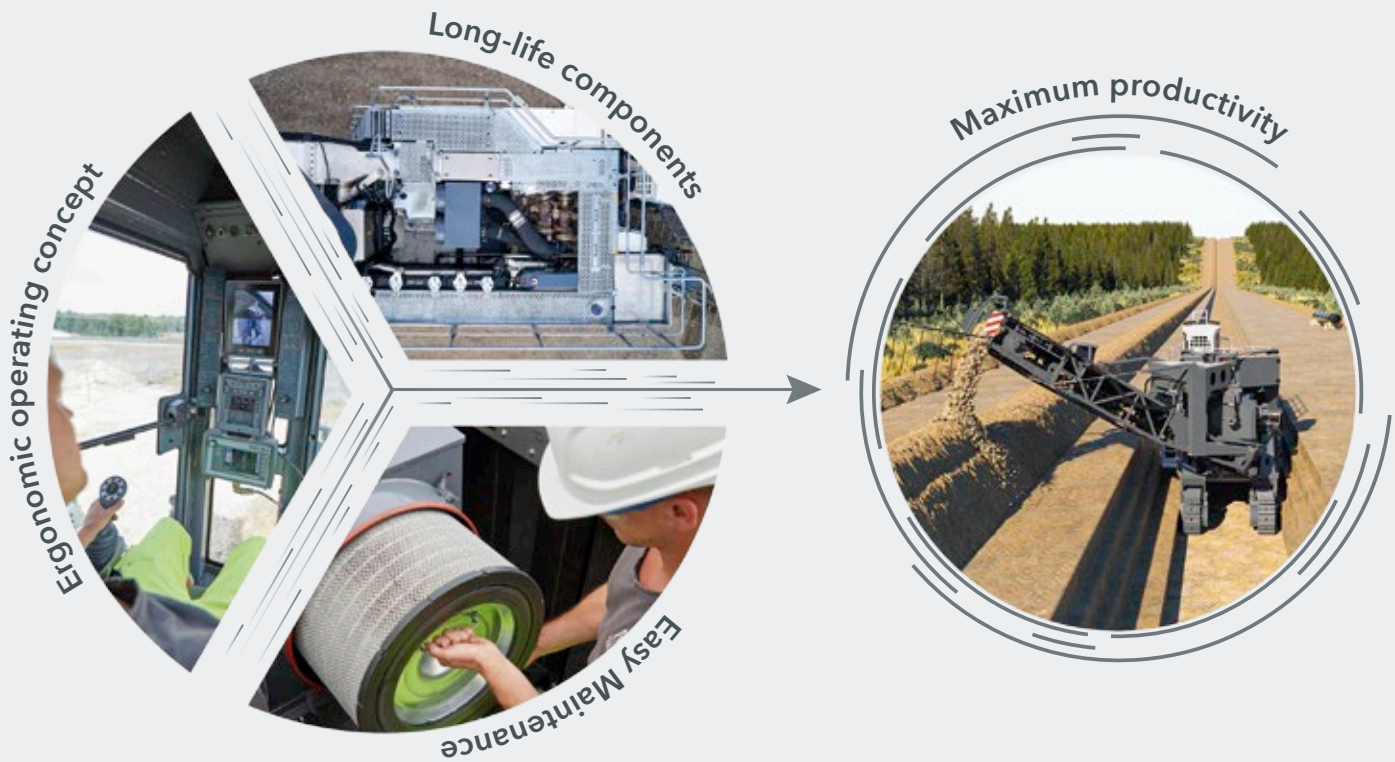

Maximum Daily Output

High machine utilization rates, maximum productivity, easy transportation

Maintenance-Friendly Design

Easily accessible servicing and maintenance points, a walk-in engine compartment, and no end of smart detail solutions enable scheduling and convenient realization of maintenance and servicing activities. The color display of the machine's on-board computer shows service reminders and diagnostics functions in plain text, which provide valuable information for preventive maintenance of the machine. This assures consistently highest levels of long-term reliability and project completion within specified deadlines.

The Human Factor - the Ergonomic Operator's Cabin

The rotatable operator's cabin with all-round glazing is mounted on the top of the front left chassis column. This provides optimal all-round vision and a constant focus on the work in progress. An operating concept in line with the latest standards of ergonomics provides an ideal workspace that is an inviting aid to high productivity and enables the operator to work for long periods with minimal fatigue. In tunnel construction configuration, the cabin is mounted at the bottom of the front left chassis column, directly above the track unit. This assures optimal working conditions when the machine height is reduced.



ULTRA-EFFICIENT CUTTING TECHNOLOGY

Wear-Resistant Pick Holder System

On a variety of infrastructure projects, working in rocky ground subjects the cutting drum, and especially the pick holder, to enormous peak loads. In view of this, all components of the cutting drum are designed to cope with the massive stresses that occur during the cutting process. The HT14 pick holder features a particularly thick and robust shank that acts as armor against wear. Perfectly matched combinations of pick holder systems and cutting drums with predefined pick spacings and, if required, additional hard facing are available for every cutting scenario.

Soft Rock and Hard Rock Cutting Drum Units

The 260 SX(i) cuts, crushes and discharges rock and stone in a single operation at a working width of 2.75 m and a depth of up to 650 mm. Hard rock cutting drums are used when cutting in particularly hard and abrasive rock. Here, the cutting drum

and the drum housing are additionally armored with special wear elements. A soft rock cutting drum is the more suitable solution when cutting in softer rock. It offers minimized resistance inside the cutting drum housing and optimal material flow at high flow rates. The cutting drum is precisely matched to the respective application and can thus achieve high area performance rates with minimal pick wear. The cutting drum housing is sealed at the sides by two hydraulically lifted side plates. An integrated sprinkler unit reduces the generation of dust.

Mechanical Cutting Drum Drive

The cutting drum is driven by a robust mechanical drive system with a low-maintenance, low-noise power belt. The outstanding efficiency of this system guarantees high cutting performance paired with low fuel consumption

01



01 A water spray system installed on the discharge conveyor reduces dust development when loading dry rock and stone.

02 High-productivity cutting drum manufactured from wear-resistant materials.

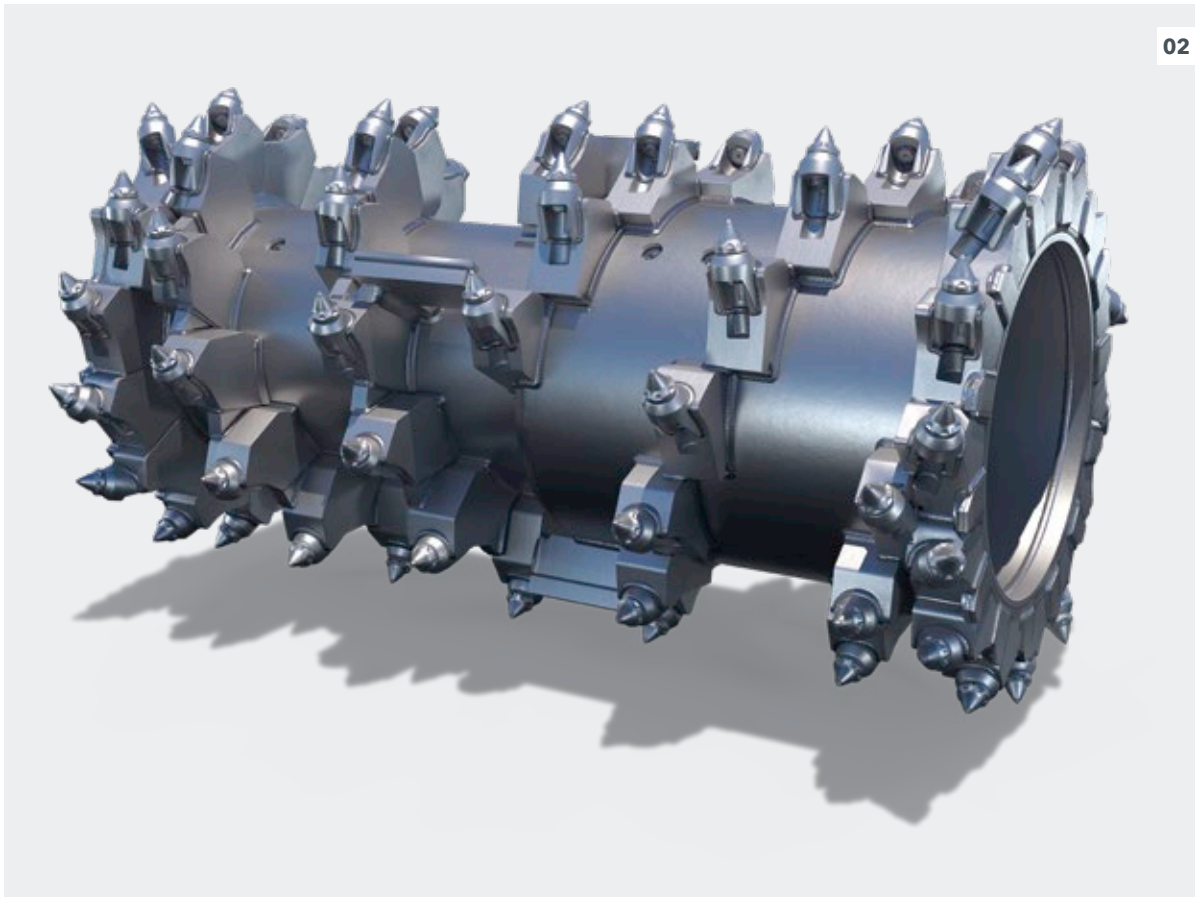

Rugged and Efficient:

Long-Life Pick Holder

HT14 Pick Holder System

The ruggedly constructed and wear-resistant HT14 pick holder system assures machine utilization rates when cutting in all types of rock and stone.

- 01** Heat-treated holder shank with enormous hardness and high strength as armor against wear
- 02** Heavy-duty shank receiver for WIRTGEN 42 mm round-shank picks
- 03** In the event of high continuous pick use, additional fixing option for cutting tools by means of a securing ring
- 04** Large opening in the top part for optimum access when changing picks
- 05** Welded pick holders stand up to even the highest loading stresses

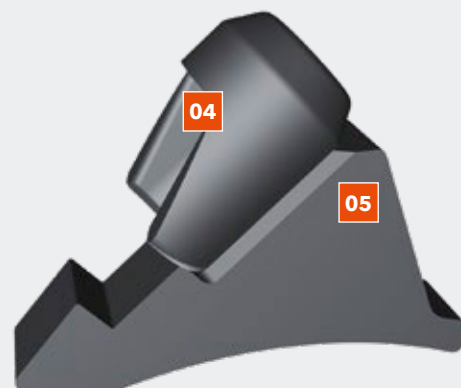
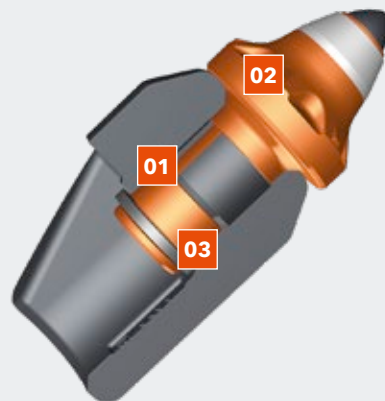

TREMENDOUS PRODUCTIVITY

Flexible and efficient material loading

High Utilization Rate:

For Maximum Productivity

Direct Loading, Sidecasting, or Cut-to-Ground

The Right Concept for Every Application



01 Efficient direct loading onto trucks.

02 Material depositing by sidecasting.



01

Several Loading Options

The 260 SX(i) is extremely versatile when it comes to offloading the mined material. The material can be offloaded directly onto a truck with the discharge conveyor, sidecast in piles to either side using the slewing function of the discharge conveyor, or deposited in windrows behind the machine. When using the cut-to-ground method, for instance when routing in tunnels, the material can also be deposited directly behind the cutting drum housing. As this method no longer requires a belt conveyor, it frees-up additional power reserves that can be used for the cutting process.

High-Performance Conveyor System

The belt conveyor system is extremely ruggedly engineered to cope with the challenging tasks often encountered on large-scale infrastructure projects. The discharge conveyor impresses with high conveying capacity, hydraulically adjustable discharge height, and a slewing angle of 90° to the left and to the right. The material cut by the cross application miner can be deposited at either side of the machine or loaded directly onto transport vehicles. This enables, for example, problem-free loading of trucks with payload capacities of up to 50 tons. What's more, the operator can continuously vary the speed of the belt independent of the engine speed to minimize belt wear dependent on the material volume and the coarseness of the mined material.

Long Refueling Intervals for High Continuous Utilization

To avoid idle times and assure maximum utilization rates, the particularly large fuel tank of the machine is dimensioned to enable 24-hours of mining at a stretch. In addition to a second, 350-liter diesel fuel tank, the 260 SX(i) also features an on-board water tank with a capacity of 3,300 liters that also helps to achieve longest possible periods of machine utilization.

Six Cutting Drum Speed Settings

Three different cutting drum speeds can be set from the operator's cabin. In addition, changing the V-belt pulley in the belt drive enables the realization of a further speed range with another three cutting drum speeds.

MAXIMUM EFFICIENCY AND PRODUCTIVITY ON EVERY JOB

Power Meets Efficiency in an Engine that's Built to Last



Rugged and Powerful
High-performance long-life engine

Powerful and Economical Diesel Engine

The 260 SX(i) is equipped with a powerful 30.5-liter diesel engine that delivers high torque and a high rated power output. Thanks to long maintenance intervals and outstanding performance under continuous peak load, the engine is ideally suited for all infrastructure construction jobs. It is rugged and powerful, and has already earned itself an excellent reputation for reliability and long life on numerous project sites. The engine also impresses with low operating costs per hour and enables outstanding utilization rates and hours of continuous operation. Featuring the latest upgrade of the Cummins QST30 engine, the machine is now at the cutting edge of current technology. The high-pressure common rail fuel system and efficient engine control ensure low fuel consumption and low exhaust gas and noise emissions. The exhaust after-treatment system also reflects the current state-of-the-art and ensures that the machine fulfills all requirements of the stringent US EPA Tier 4f / EU Stage 5 exhaust emission standards (260 SX i).

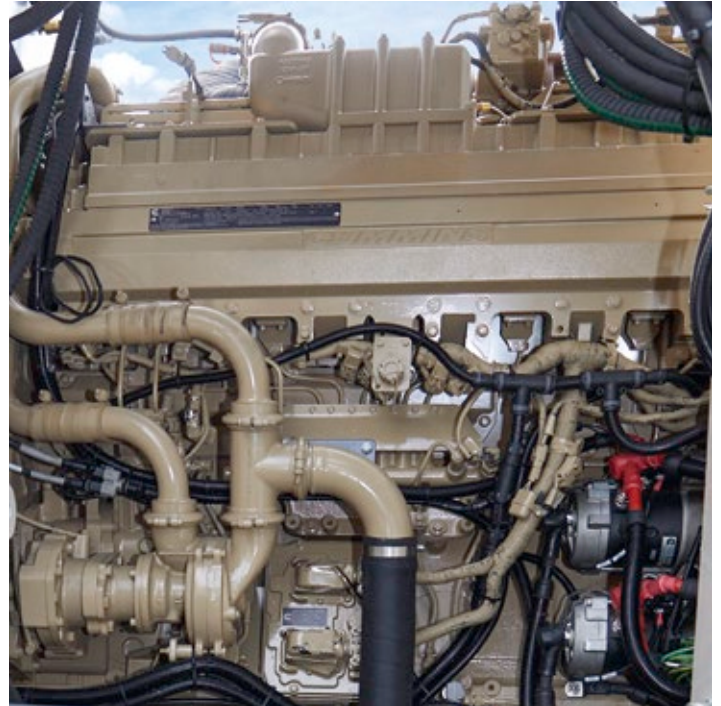

Variable Cooler Fan Control

The variable cooler fan control regulates the fan speed according to the actual cooling demand. This assures optimal exploitation of performance potential, low fuel consumption, and reduces the cost per cubic meter of material mined. optimal power utilization, lowers fuel consumption, and reduces the extraction costs per ton.



EASY SERVICING AND MAINTENANCE

Minimal Maintenance Time and Effort

Users demand the highest possible utilization rate from their 260 SX(i). This means that the time and effort expended on maintenance must be minimal. A smart maintenance concept is the key to maximizing machine utilization and maintaining consistently high levels of productivity. Regular servicing and maintenance are essential for assuring highest possible operational reliability, preventing unexpected production stoppages, and extending the service life of components. The machine's on-board computer helps the operator to implement the maintenance concept. It displays service reminders,

error messages, and diagnostics functions in plain text. The automatic, self-monitoring central lubrication system (optional) permanently guarantees reliable delivery of lubricants to all lubrication points and reduces maintenance time and effort.

Direct Access

The walk-in engine compartment enables direct access to all service and maintenance points. The machine's air, fuel, and hydraulic oil filters are all easy accessible. Checking fluid levels takes only a few moments. Filter elements can be quickly and easily removed and replaced.

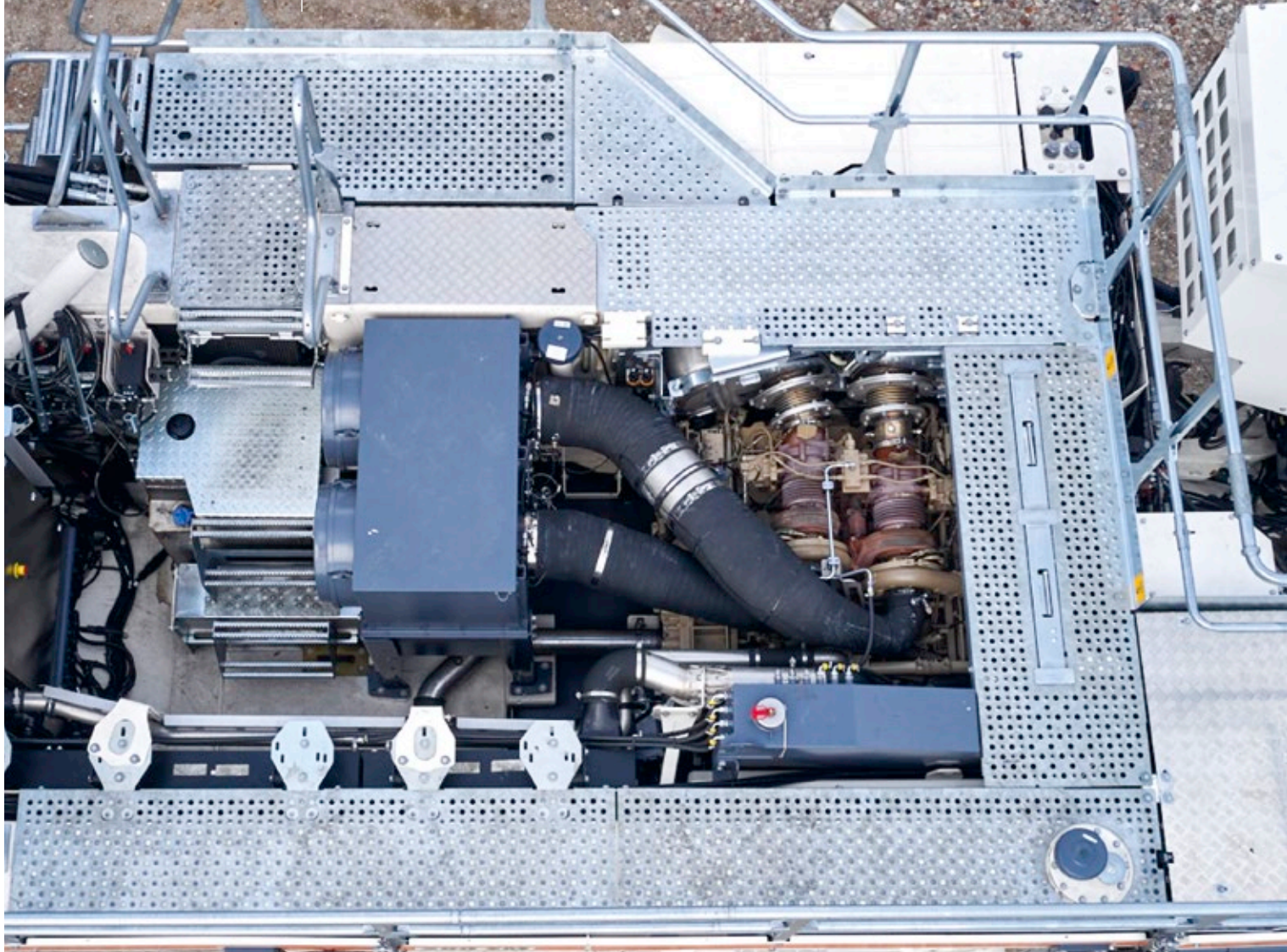

Time Is Money

Fast Servicing

Minimal Idle Times

Safely changing a pick with the hydraulic pick ejector and the electro-hydraulic cutting drum rotation device takes only a matter of minutes.

Cooling Fan and Diesel Tank Hinge-Mounted for Easy Maintenance Access

The cooling fan on the right-hand side of the machine and the diesel tank can be unlocked and then swung out for maintenance. This enables easy cleaning of the radiator and the tank and provides additional access to the engine from the side for maintenance purposes.

Fast Exchange of Primary Conveyor Belt

The dismantling and reassembly of the primary conveyor for belt replacement is made easier by a maintenance shaft. The discharge conveyor can remain on the machine during the process, which can be completed within around six hours.



01



02



03

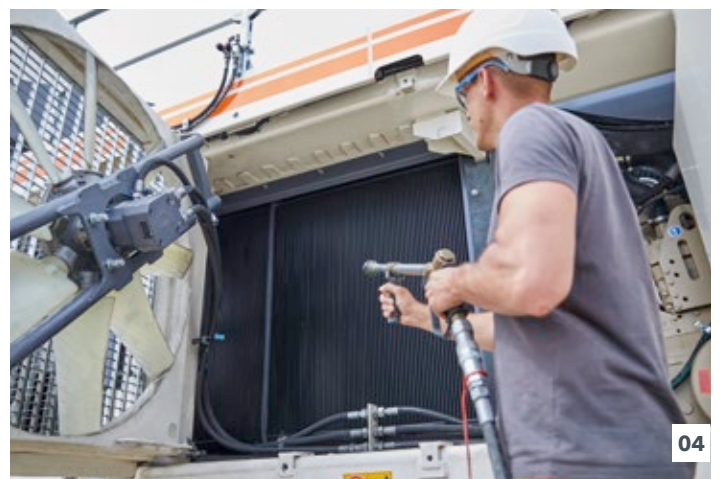

04



01 The hydraulic pick ejector and the remote control for the cutting drum rotation device are easily accessible and always ready to use

02 The electro-hydraulically powered cutting drum rotation device and the hydraulic pick ejector significantly increase the machine's utilization rate

03 All servicing points are easily accessible

04 Access to the engine and cooling systems from the side

UNCOMPROMISING SAFETY

Safety Always Takes Absolute Priority

The safety of operating and maintenance personnel always tops our list of priorities. For instance, all access ladders and walkways are constructed with non-slip materials and are also brightly illuminated - as are all servicing points.

The Operator's Cabin Sets Entirely New Standards

On the 260 SX(i), a dust-sealed pressurized cabin and air filtration effectively prevent the ingress of dust into the operator's workplace. The cabin is fitted with a seat for the operator, an integrated, certified ROPS / FOPS set-up, and an additional seat for a trainer for safe practical training of inexperienced operators on the machine.

Lockout-Station

Inadvertent powering-up of the machine during maintenance can be prevented by activating the mechanical power-on-disabled switch for the electrical system. When the machine is idle, both the electric starter circuit for the diesel engine and all battery power to the machine can be deactivated to ensure the safety of service or maintenance personnel.

Safety First!

For the operator and everyone in the vicinity of the machine



- 01** If required, the lockout-station deactivates the electric starter circuit for the diesel engine or the entire battery power supply to the machine
- 02** Comprehensive machine lighting concept for the illumination of all relevant working areas



Comprehensive Machine Lighting

At night - and especially when working in tunnels - safe operation is consistently ensured by bright illumination of all relevant working areas on and around the machine. The high-powered lighting system on the 260 SX(i) comprises LED floodlights for the working areas, lamps on the discharge conveyor, and brightly-lit access ladders and walkways.

When working at night, eye-fatigue is prevented by cabin lighting with a reddish tone that provides a comfortable ambient light in the cockpit without dazzling the operator. The comprehensive lighting system also features a practical "Welcome and Go Home Lighting" function that ensures that the operator doesn't have to begin or end shifts in the dark.

OUTSTANDING OPERATOR-COMFORT - PERFECT ERGONOMICS

Stress-Free Workplace

For maximum productivity

Everything under Control

Ergonomic operating concept

Automated Processes

Automatic functions reduce the operator's workload

01

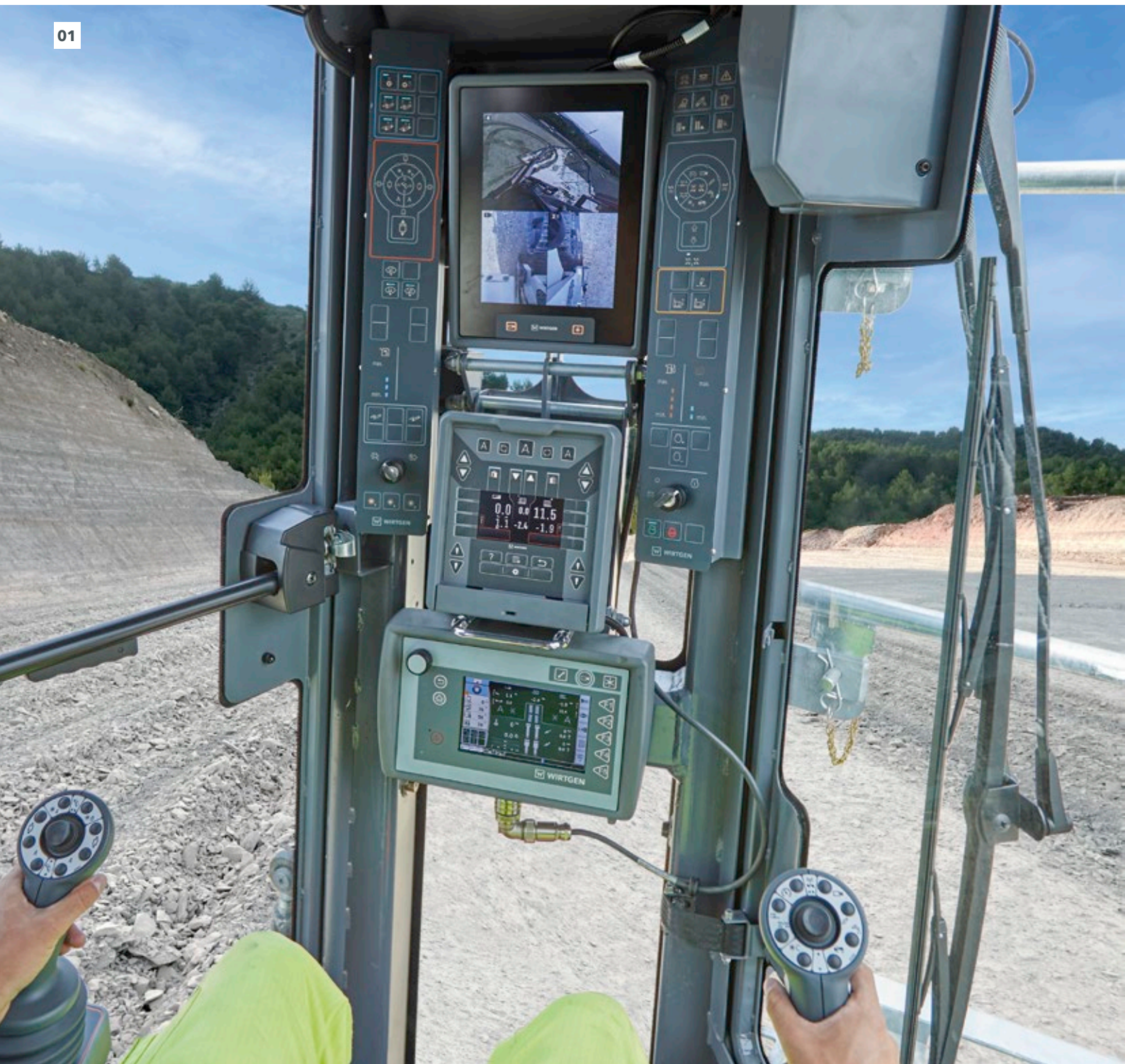

Ergonomically Designed Cabin

The operator's cabin has been completely redesigned and is now characterized by comfort, ergonomically designed control elements, a premium look and feel, and modern design. As ergonomics, comfort, and operator-friendliness are significant factors for assuring profitability, its construction integrates the latest findings from the field of ergonomics. They enhance wellbeing, which in turn increases the productivity of both the operator and the machine.

Rotatable Cabin

The operator's cabin is decoupled from the body of the machine and is mounted on the top of the front left chassis column - or at the bottom, for working in tunnels. The operator's cabin can be rotated by 90° to either side. This means that the machine operator has an ideal overview of the entire working area at all times. On the one side, the operator can visually monitor the loading procedure and, on the other, has an overview of the working area in front of the machine. All essential displays, the on-board computer, and the control panel of the **LEVEL PRO ACTIVE** leveling system are centrally arrayed in front of the operator. This means that the most important process information is available to the operator at all times. Instead of the operator's seat being rotated to the side into its working position as is otherwise usual, the entire cabin is rotated and all controls and displays now always stay in the same position and remain easily accessible for the operator.

High-Quality Camera / Monitor System with up to 6 Cameras

The 260 SX(i) can be equipped with up to 6 cameras. This makes it much easier for the operator to keep an eye on what's going on around and on the machine. The cameras are mounted on the discharge conveyor, on the left-hand and right-hand side plates, and at the rear of the machine. The image data from these cameras is displayed on a 10.4" high-resolution monitor with high viewing angle stability. The layout of the visual content displayed on the monitor can be freely chosen. The cameras themselves can be tilted and panned and are automatically heated at low ambient temperatures.

Joystick-Control in the Multifunctional Armrests

The 260 SX(i) is controlled with two joysticks integrated in the multifunctional armrests. The controls for all essential machine functions can be found on the multifunctional joysticks. The ergonomically designed control elements are integrated into the armrest of the operator's seat.



02



03

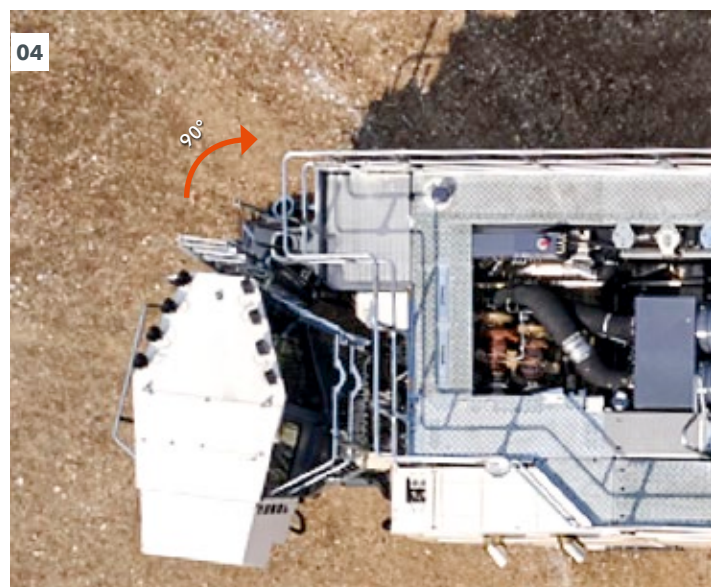

04

- 01 Ergonomics and comfort increase the operator's well-being and performance
- 02 Multifunctional joystick in the armrest.
- 03 The cabin can be rotated to either side...
- 04 ... by 90°.

OPTIMAL ADVANCE AND FAST TURNING IN TIGHT SPACES

Rugged Track Units for Outstanding Traction and Maneuverability

Experience shows that the terrain on infrastructure projects often presents unexpected challenges. In view of this, optimal traction, maneuverability, and sufficient ground clearance are absolutely essential. When it comes to this, the 260 SX(i) has what it takes. Specially adapted to meet the requirements of infrastructure projects, ISC (Intelligent Speed Control) is an active track chain control system that ensures continuous and consistent traction. An electronic traction control system provides controlled reduction of the slipping of individual track units.

At the same time, ISC adapts the speed of the inner and outer track units when advancing in curves. This enormously increases the maneuverability of the machine and reduces wear. Continuous speed adjustment is possible across the entire spectrum in both travel mode and working mode.



Relentless Traction

Optimal traction

Very Good Maneuverability

Ackermann steering and Intelligent Speed Control (ISC)

01 A turning circle of under 9 meters and outstanding maneuverability enable fast turning maneuvers.

02 Thanks to **LEVEL PRO ACTIVE**, the cutting drum always reliably maintains the preset cutting depth, even in the case of particularly uneven ground.



Four Steering Modes and Separately Steerable Rear Axle

A choice of four steering modes for the hydraulic all-track steering lends the machine impressive maneuverability. The rear axle can be steered separately at any time at the press of a button. For positioning, the front and rear track units are steered in opposite directions, while, on long, straight cuts, only the front unit is used for steering. In crab steering mode - for lateral repositioning of the machine - all four track units are steered in the same direction.

Hydraulic All-Track Ackermann Steering

Hydraulic all-track Ackermann steering enables tight turning radii and low-wear turning maneuvers. In combination with active ISC (intelligent speed control) for minimal track slip, this guarantees optimal maneuverability in tight spaces. This means that the 260 SX(i) can be rapidly maneuvered and that

the productive cutting process is interrupted for as short a period as absolutely necessary.

Automatic Parallel to Surface Leveling

Automatic parallel to surface leveling (PTS) assists the operator especially when lowering and raising the machine into and out of the cut. Machine height adjustment is uniformly applied at the front and rear to ensure that the adjustment is always parallel to the initial position. This automatic function can be deactivated at the press of a button. When relocating or repositioning the machine, the operator can also activate automatic cross-slope control for transport movements. At the press of a button, this ensures that the cross-slope of the machine remains constant when relocating and thus additionally reduces the machine operator's workload.



LEVEL PRO ACTIVE

Precise Leveling Integrated in the Machine Control System

Intuitive and Reliable LEVEL PRO ACTIVE Leveling System

The new **LEVEL PRO ACTIVE** leveling system is integrated in the on-board computer of the 260 SX(i). The excellent performance of the system has been clearly demonstrated in numerous road construction projects. The functionalities of the system have been expanded with ergonomically designed control panels that make operating a simple and intuitive process. The current leveling attitude of the machine is precisely determined by components such as position measuring systems in the side plate lifting cylinders and a cross-slope sensor.

The positioning data measured in this way enable the production of incomparably level areas and roadways. Full integration in the machine control system also enables a high degree of automation, as essential machine functions are directly connected to one another.

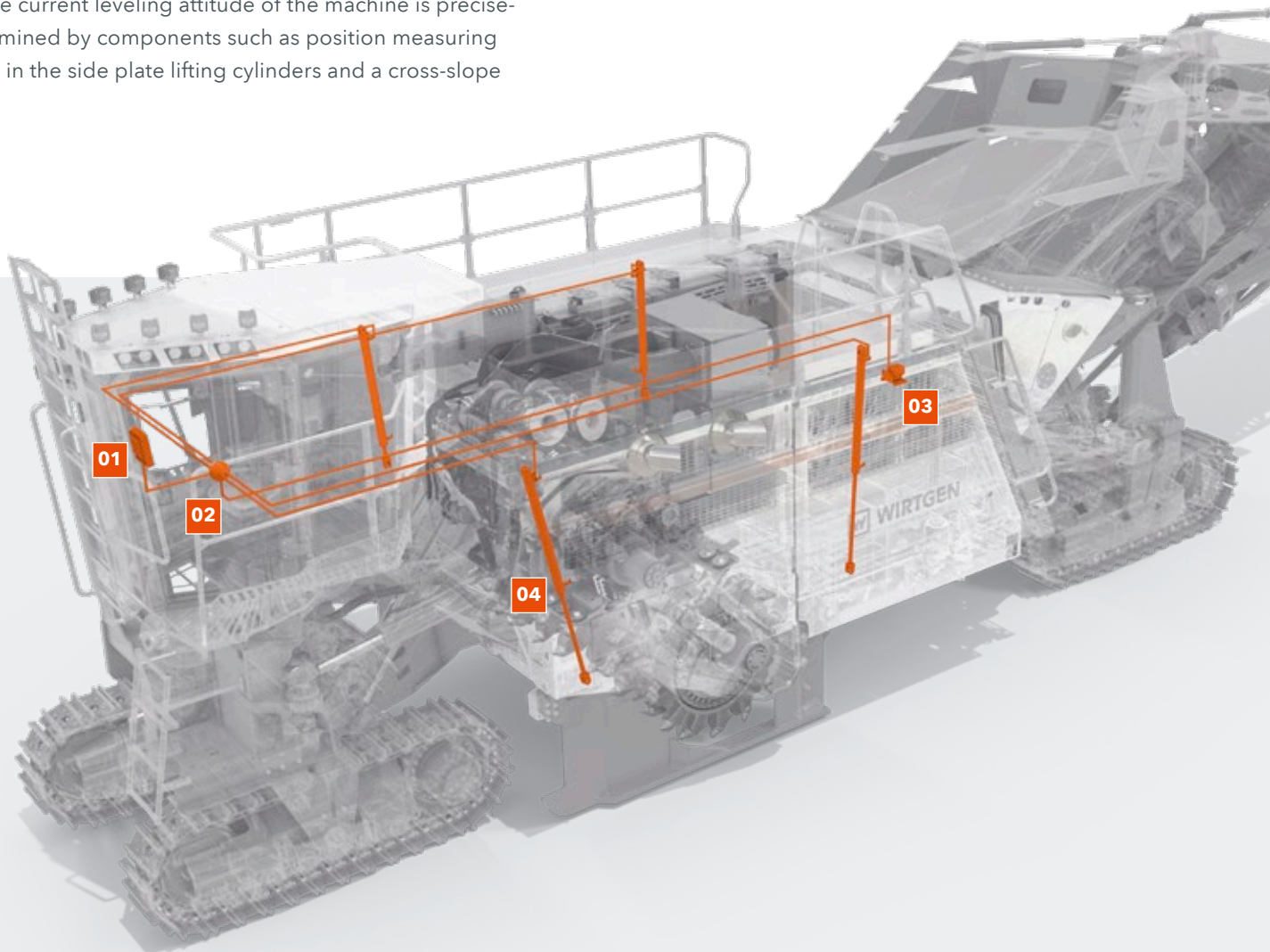

New Additional Features and Automated Functions

The **LEVEL PRO ACTIVE** leveling system offers numerous additional features and automated functions that help to make the operator's job easier. This leads to faster and more precise workflows. For instance, the automatic function for the construction of evenly sloped ramps can be accessed at the press of a button. Automatic parallel to surface leveling allows the determination of the ideal center of gravity and can be used to maximize all-terrain mobility.

Manual Floating Positioning of Side Plate Lifting Cylinders

Each of the side plate lifting cylinders can be independently pressurized. This means that the side plates can be actively tilted and, in loose ground, float on top of the material cut by the machine. This effectively prevents the side plates sinking in to soft or loose ground.

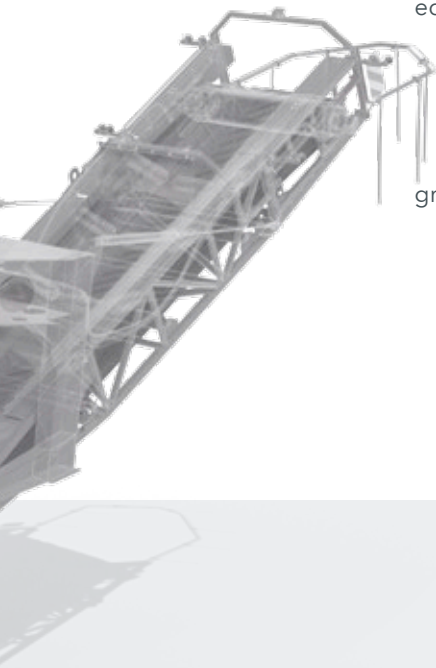

Fast and Precise Height Adjustment

The powerful lifting cylinders enable extremely agile height adjustment, which in turn increases the leveling precision of the machine.

3D-Leveling

The 260 SX(i) can be fitted with an interface compatible with commonly available 3D leveling systems. When interfaced with the machine, the 3D-system interacts directly with the machine control system and controls the leveling process. This enables the creation of defined planes and surfaces previously constructed in a 3D-terrain model

3D-Interface

Thanks to an integrated standard interface, the 260 SX(i) can be equipped with all commonly available third party 3D machine control systems without any problems.

260 SX(i) Leveling Sensors

- 01 On-board computer and 5-inch control panel for **LEVEL PRO ACTIVE**
- 02 Machine control system
- 03 Cross-slope sensor
- 04 Hydraulic side plate lifting cylinder with integrated displacement sensor

BUILT FOR THE FUTURE

Cutting Rock without Drilling and Blasting

Environmentally Conscious

Cutting rock without drilling or blasting

Resource-Friendly

Precise operations, leaner processes



Environmentally Compatible Machine Technology

These days, minimizing exhaust fumes, noise, and dust while maintaining maximum performance and productivity is more important than ever before. WIRTGEN offers innovative technologies that minimize environmental impact, conserve natural resources, and simultaneously maintain productivity.

Environmentally Compatible and Efficient - without Drilling and Blasting

The cutting process is almost vibration-free and causes only very little in the way of dust and noise emissions. The process can therefore also be employed in urban areas and in the immediate vicinity of buildings or buried utility pipes and cables. The 260 SX(i) cuts routes with a final profile and therefore saves the costs otherwise required for the processing of additionally excavated material and leveling.



Low Specific Fuel Consumption

Advanced engine management, load-dependent engine speed control, a choice of six cutting drum speeds, and variable cooler fan control ensure minimal fuel consumption and low CO₂ emissions while maintaining maximum productivity.



Minimal Water Usage

Efficient water management with automatic functions for economical water usage and longer continuous working intervals



Reduced Dust Emissions

The enclosed material transfer point on the conveyor unit, the sealed cutting drum housing, and the water spraying system effectively reduce dust emissions from the machine.



Reliable Lubrication for Maximum System Functionality

The automatic central lubrication system reliably delivers lubricants to all lubrication points. The entire lubricant cycle is continuously monitored to detect damage or leakage in good time



Low Pick Consumption

Application-specific configuration of cutting drum units and wear-resistant pick holder systems enables optimum pick utilization.

The 260 SX(i) cross application miner provides solutions for the most challenging infrastructure projects and impresses with maximum utilization rates and highest daily productivity. Its applications cover a range of tasks such as routing work in road and railroad construction, the excavation of harbor basins, trenching for buried pipelines, and includes jobs in tunnels. The compact machine has a short, lifting and slewing rear discharge conveyor for loading to trucks in extremely confined spaces and the machine height can be further reduced by removing the discharge conveyor and superstructure for working on special jobs in tunnels.



TECHNICAL SPECIFICATIONS	260 SX	260 SXi
Cutting drum		
Max. cutting width	2,750 mm	
Cutting depth ¹⁾	0 - 650 mm	
Cutting diameter	1,500 mm	
Engine		
Manufacturer	CUMMINS	
Type	QST 30	
Cooling system	Water	
Number of cylinders	12	
Rated power output at 2,100 rpm	783 kW / 1050 HP / 1065 PS	
Displacement	30.5 l	
Fuel consumption under full load	206 l/h	191.5 l/h
Sound power level according to DIN EN 500-2 engine operator's platform	≤ 120 dB(A) ≥ 78 dB(A)	
Exhaust emission standard	EU not rated / US EPA Tier 2	EU Stage 5 / US EPA Tier 4f
Electrical System		
Power supply	24 V	
Tank Capacities		
Diesel fuel	2,350 l	
AdBlue® / DEF ²⁾	—	300 l
Hydraulic oil	570 l	
Water	3,300 l	

TECHNICAL SPECIFICATIONS	260 SX	260 SXi
Handling Characteristics		
Working speed	0 - 44 m/min (0 - 2.6 km/h)	
Gradeability ³⁾	20 %	
Max. cross slope	8%	
Track Units		
Type	B7	
Track units front / rear (L x W x H)	3,040 x 450 x 1,060 mm	
Loading System		
Belt width, primary conveyor	1,400 mm	
Length of primary conveyor	6,440 mm	
Belt width, discharge conveyor	1,400 mm	
Length of discharge conveyor	8,000 mm	
Shipping Dimensions		
Transport by sea, variant 1		
> 1 st shipping unit: Module 1 (chassis, track units, engine station, primary conveyor, operator's cabin, ballast weights) (L x W x H)	13,320 x 3,720 x 3,400 mm	
> 2 nd shipping unit: Module 2 (carrier, conveyor suspension system, transport cradle) (L x W x H)	6,370 x 3,000 x 2,730 mm	
> 3 rd shipping unit: Module 3 (discharge conveyor) (L x W x H)	8,200 x 2,200 x 1,350 mm	
> 4 th shipping unit: Module 4 (cutting drum unit) (L x W x H)	2,400 x 3,850 x 1,800 mm	
Transport by sea, variant 2		
> 1 st shipping unit: Module 1 (chassis, track units, engine station, operator's cabin) (L x W x H)	13,320 x 3,720 x 3,400 mm	
> 2 nd shipping unit: Module 2 (carrier, conveyor suspension system, transport cradle) (L x W x H)	6,370 x 3,000 x 2,730 mm	
> 3 rd shipping unit: Module 3 (discharge conveyor) (L x W x H)	8,200 x 2,200 x 1,350 mm	
> 4 th shipping unit: Module 4 (primary conveyor) (L x W x H)	6,000 x 2,200 x 1,000 mm	
> 5 th shipping unit: Module 5 (cutting drum assembly) (L x W x H)	2,400 x 3,850 x 1,800 mm	
> 6 th shipping unit: Module 6 (ballast weights) (L x W x H)	2,440 x 140 x 1,170 mm / 1,280 x 350 x 500 mm	

¹⁾ The maximum cutting depth may deviate from the value indicated due to tolerances and wear

²⁾ AdBlue® is a registered trademark of the German Association of the Automotive Industry (Verband der Automobilindustrie e. V.; VDA)

³⁾ The gradeability of the machine depends on the ground conditions of the working environment

⁴⁾ Machine weight, half weight of all consumables, on-board tool kit, machine operator, excluding optional equipment

TECHNICAL SPECIFICATIONS	260 SX	260 SX i
Weight, Base Machine		
Unladen weight of machine without consumables	98,320 kg	98,920 kg
Operating weight, CE ⁴⁾	101,110 kg	101,875 kg
Maximum operating weight (full tanks, full range of equipment)	103,900 kg	104,830 kg
Transport Weight of Individual Components		
Transport by sea, variant 1		
> Weight of 1 st shipping unit: Module 1 (chassis, track units, engine station, primary conveyor, operator's cabin, ballast weights)	74,050 kg	74,650 kg
> Weight of 2 nd shipping unit: Module 2 (carrier, conveyor suspension system, transport cradle)		5,400 kg
> Weight of 3 rd shipping unit: Module 3 (discharge conveyor)		3,800 kg
> Weight of 4 th shipping unit: Module 4 (cutting drum assembly)		18,000 kg
> Crate with add-on components		5,000 kg
Transport by sea, variant 2		
> Weight of 1 st shipping unit: Module 1 (chassis, track units, engine station, operator's cabin)	66,550 kg	67,150 kg
> Weight of 2 nd shipping unit: Module 2 (carrier, conveyor suspension system, transport cradle)		5,400 kg
> Weight of 3 rd shipping unit: Module 3 (discharge conveyor)		3,800 kg
> Weight of 4 th shipping unit: Module 4 (primary conveyor)		4,200 kg
> Weight of 5 th shipping unit: Module 5 (cutting drum assembly)		18,000 kg
> Weight of 6 th shipping unit: Module 6 (ballast weights)		3,300 kg
> Crate with add-on components		5,000 kg
Weight of Consumables		
Water		3,300 kg
Fuel (0.83 kg/l)		1,950 kg
AdBlue® / DEF ²⁾ (1.1 kg/l)	—	330 kg
Additional Weights		
Machine operator and tools		
> Machine operator		75 kg
> On-board tool kit		30 kg

¹⁾ The maximum cutting depth may deviate from the value indicated due to tolerances and wear

²⁾ AdBlue® is a registered trademark of the German Association of the Automotive Industry (Verband der Automobilindustrie e. V.; VDA)

³⁾ The gradeability of the machine depends on the ground conditions of the working environment

⁴⁾ Machine weight, half weight of all consumables, on-board tool kit, machine operator, excluding optional equipment

260 SX(i) TRANSPORT MODULES

Transport modules for the transportation of the 260 SX(i) cross application miner by sea, variant 1

1st shipping unit: Module 1 (chassis, track units, engine station, primary conveyor, operator's cabin, ballast weights), width 3,720 mm

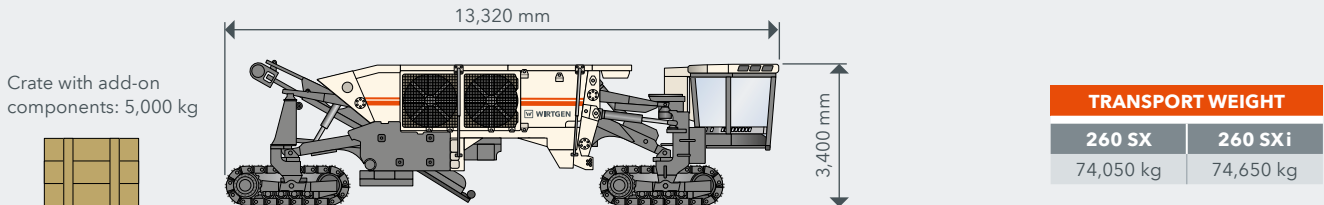

2nd shipping unit: Module 2 (carrier, conveyor suspension system, transport cradle), width 3,000 mm

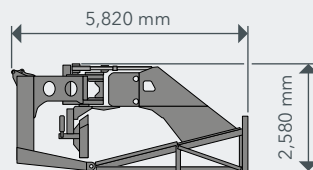

TRANSPORT WEIGHT	
260 SX	260 SXi
5,400 kg	

3rd shipping unit: Module 3 (discharge conveyor), width 2,200 mm

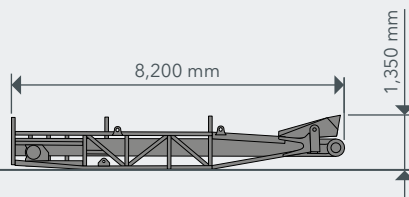

TRANSPORT WEIGHT	
260 SX	260 SXi
3,800 kg	

4th shipping unit: Module 4 (cutting drum assembly), width 3,850 mm

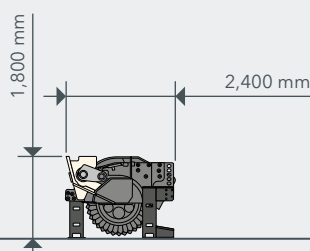

TRANSPORT WEIGHT	
260 SX	260 SXi
18,000 kg	

260 SX(i) TRANSPORT MODULES

Transport modules for the transportation of the 260 SX(i) cross application miner by sea, variant 2

1st shipping unit: Module 1 (chassis, track units, engine station, operator's cabin), width 3,720 mm

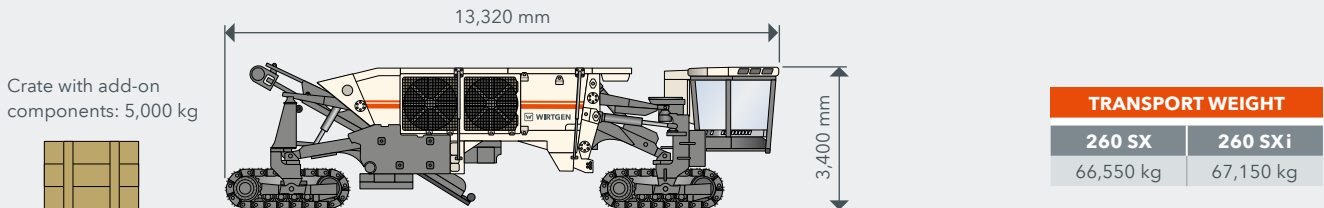

2nd shipping unit: Module 2 (carrier, conveyor suspension system, transport cradle), width 3,000 mm

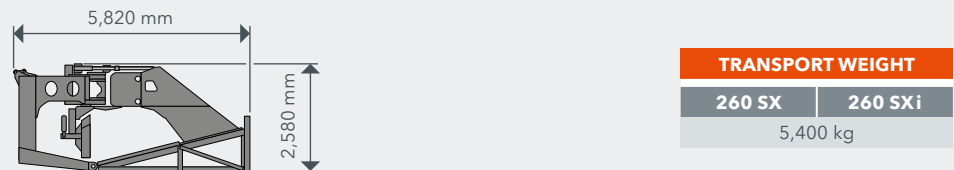

3rd shipping unit: Module 3 (discharge conveyor), width 2,200 mm

TRANSPORT WEIGHT	
260 SX	260 SXi
3,800 kg	

4th shipping unit: Module 4 (primary conveyor), width 2,200 mm

TRANSPORT WEIGHT	
260 SX	260 SXi
4,200 kg	

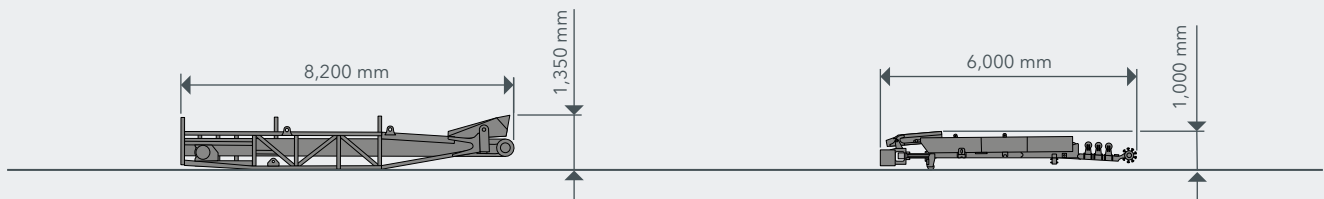

5th shipping unit: Module 5 (cutting drum assembly), width 3,850 mm

TRANSPORT WEIGHT	
260 SX	260 SXi
18,000 kg	

6th shipping unit: Module 6 (ballast weights), width 140 mm

width 350 mm

TRANSPORT WEIGHT	
260 SX	260 SXi
3,300 kg	

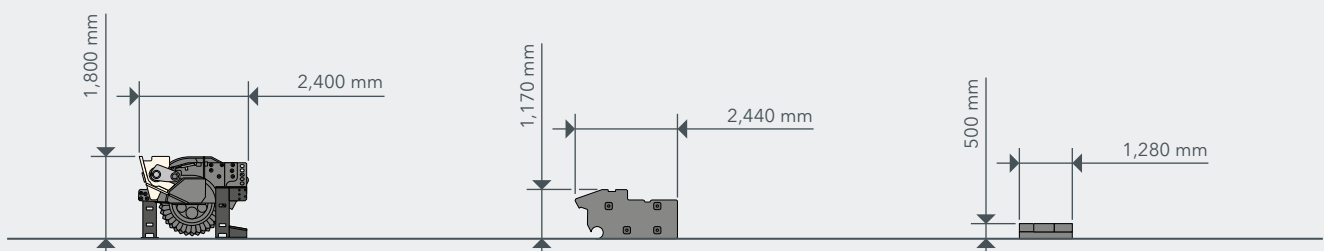

STANDARD EQUIPMENT	260 SX	260 SXi
Basic Machine		
> Base machine with engine	■	■
> Reduced diesel consumption and low noise emissions as a result of temperature-controlled fan speed	■	■
> Lockout station - mechanical lockout of diesel engine or of the electrical system during machine stoppages / maintenance	■	■
> Operating fluids for using the machine in warm weather conditions (from -20 °C / -4 °F)	□	□
> Standard radiator	□	□
Cutting Drum Unit		
> Cutting drum housing for soft rock with coaxial drive	□	□
Cutting Drums		
> Robust and efficient mechanical cutting drum drive via power belts with an automatic belt tensioner	■	■
> Cutting drum speed can be adjusted into 6 steps for optimum working results. 3 selectable engine speeds and adjustable belt pulley arrangements	■	■
> Electrohydraulically driven cutting drum rotation device for quick and safe pick replacement; an electrohydraulic unit permits operation with the diesel engine switched off	■	■
> Cutting drum FB2750 HT14 LA50 with 76 picks - soft rock	□	□
Loading of the Mining Material		
> Powerful, liftable and pivoting rear loading conveyor designed to load road-approved trucks	■	■
> Conveyor unit 260 SX(i)	□	□
Machine Control and Leveling System		
> Advance control across the entire speed range via an ergonomic joystick with proportional control characteristics	■	■
> Automatic feed control designed to assist the operator maintains the engine's ideal operating point	■	■
> Maximum possible traction force on the track units thanks to hydraulic flow dividers (differential lock on all track units)	■	■
> Cutting depth regulation with an integrated levelling system with side plates and LEVEL PRO ACTIVE , integrated into the machine display	■	■
> The standard transverse slope control maintains the machine's transverse tilt regardless of the terrain; this enables exact surface levels, either horizontal or slanted, to be created	■	■
Operator's Cabin		
> Comfortable, all-round glazed, air-conditioned and soundproofed cabin, mounted on the front left chassis column and rotatable	■	■
> Cabin, on flexible mountings, with heater	■	■
> Air-conditioning system with cooling and heating functions	■	■
> Equipped with an air-cushioned seat and all the necessary control instruments integrated into the armrests	■	■
> Trainer seat to ensure safe, hands-on driver training	■	■
> Illuminated access ladder and walkway to the operator's cabin	■	■
> Reversing camera with graphical reversing assistant	■	■
> Includes 12 V and 24 V sockets and a 5 V USB port	■	■
> "Welcome-and-Go-Home light" function with LED lighting in the ladder area	■	■

STANDARD EQUIPMENT	260 SX	260 SXi
Chassis and Height Adjustment		
> Track units with exceptionally sturdy double-grouser track pads in heavy-duty design for mining applications	■	■
> Infinitely variable, hydraulic four-track drive	■	■
> All-track steering - The steering types "crab", "cornering" or "straight ahead" are possible; in addition, the front and rear track units can be steered separately	■	■
> Machine height is adjusted via swing arms, with two hydraulic cylinders on each swing arm	■	■
> Version with four B7 track units (5 rollers) with double grouser steel track pads	□	□
Miscellaneous		
> Water spray bar on the cutting drum assembly and on the material transfer points	■	■
> High-pressure water cleaner (40 bar, max. 135 l/min) with a washing lance to clean the machine	■	■
> Comprehensive LED lighting system, 24 V	■	■
> Rotary beacon LED 24 V	■	■
> Extensive safety package including easily accessible emergency stop switches, an integrated machine safety feature, protecting it from unintended transverse tilts, large non-slip walkways, a lockable main switch and starting switch and position lights	■	■
> European type certification, EuroTest mark and CE conformity	■	■
> Central lubrication system	■	■
> Standard painting in RAL 9001 (cream)	□	□
> WITOS - professional telematics solution for machine operation and service optimization	□	□

■ = Standard equipment

□ = Standard equipment, can be replaced with optional equipment if desired

□ = Optional equipment

OPTIONAL EQUIPMENT	260 SX	260 SXi
Basic Machine		
> Consumables for use in cold weather conditions (from -15°C / 5°F)	<input type="checkbox"/>	<input type="checkbox"/>
> High-performance radiator	<input type="checkbox"/>	<input type="checkbox"/>
Cutting Drum Unit		
> Cutting drum housing for hard rock with reinforced drive	<input type="checkbox"/>	<input type="checkbox"/>
> Drum housing shipped separately	<input type="checkbox"/>	<input type="checkbox"/>
> Heavy-duty rollers to help with the assembly of the drum housing	<input type="checkbox"/>	<input type="checkbox"/>
Cutting Drums		
> Cutting drum FB2750 HT14 LA50 with 76 picks for use in conjunction with the milling drum housing with a reinforced drive	<input type="checkbox"/>	<input type="checkbox"/>
> Hydraulic pick ejector for HT14 toolholder system	<input type="checkbox"/>	<input type="checkbox"/>
Loading of the Mining Material		
> Machine equipment for depositing material in the "cut-to-ground" method	<input type="checkbox"/>	<input type="checkbox"/>
Machine Control and Leveling System		
> Level control 3D leveling pre-equipment	<input type="checkbox"/>	<input type="checkbox"/>
> Additional control panel LEVEL PRO ACTIVE	<input type="checkbox"/>	<input type="checkbox"/>
Operator's Cabin		
> Radio system with two speakers and antenna	<input type="checkbox"/>	<input type="checkbox"/>
> Auxiliary heating for cabin	<input type="checkbox"/>	<input type="checkbox"/>
> "Tunneling" version of machine equipment for tunnel construction	<input type="checkbox"/>	<input type="checkbox"/>
Chassis and Height Adjustment		
> Version with four B8 track units (4 rollers) with double grouser steel track pads	<input type="checkbox"/>	<input type="checkbox"/>
Miscellaneous		
> Painting in one special color (RAL)	<input type="checkbox"/>	<input type="checkbox"/>
> Model without WITOS	<input type="checkbox"/>	<input type="checkbox"/>
> Electrical preheating (400 V) as a cold start aid	<input type="checkbox"/>	<input type="checkbox"/>
> Hydraulically operated filling pump for water refilling	<input type="checkbox"/>	<input type="checkbox"/>
> Wiggins fast-fill system for diesel refueling	<input type="checkbox"/>	<input type="checkbox"/>
> Wiggins fast-fill system for AdBlue® refilling	—	<input type="checkbox"/>
> Camera system consisting of 4 cameras and 1 screen, series system expandable up to 6 cameras	<input type="checkbox"/>	<input type="checkbox"/>
> System used to detect material by means of a visual separation layer indicator	<input type="checkbox"/>	<input type="checkbox"/>
> High-performance lighting system including 8 LED working lights, 24 V	<input type="checkbox"/>	<input type="checkbox"/>
> Dismantling the machine for transporting	<input type="checkbox"/>	<input type="checkbox"/>
> Workshop container 20' including workshop equipment	<input type="checkbox"/>	<input type="checkbox"/>
> Workshop equipment - tools	<input type="checkbox"/>	<input type="checkbox"/>
> Workshop equipment - auxiliary equipment and consumables	<input type="checkbox"/>	<input type="checkbox"/>
> Workshop equipment - metric fastening elements	<input type="checkbox"/>	<input type="checkbox"/>
> Workshop equipment - electrical repairs	<input type="checkbox"/>	<input type="checkbox"/>
> Workshop equipment - hydraulic components	<input type="checkbox"/>	<input type="checkbox"/>
> Workshop equipment - hydraulic press	<input type="checkbox"/>	<input type="checkbox"/>
> Workshop equipment - hoses for emergency repairs	<input type="checkbox"/>	<input type="checkbox"/>
> Workshop equipment - first service after 50 h	<input type="checkbox"/>	<input type="checkbox"/>

■ = Standard equipment

▒ = Standard equipment, can be replaced with optional equipment if desired

□ = Optional equipment

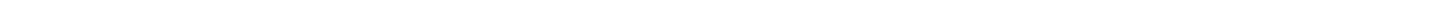

**WIRTGEN GmbH**

Reinhard-Wirtgen-Str. 253578
Windhagen
Germany

T: +49-2645-131-0
F: +49-2645-131-392
M: info@wirtgen.com

 www.wirtgen.de



For further information, please scan the code.