

High-Performance In-Situ Rock Crushing and Homogeneous Mixing

# ROCK CRUSHER WRC 240 (i)



US RELEASE

# HIGH-PERFORMANCE IN-SITU ROCK CRUSHING AND HOMOGENEOUS MIXING



The innovative Rock Crusher with its high-performance crushing, screening, and mixing unit can crush, process, and homogenize hand-packed pavement layer (e.g. Telford base), concrete fragments, cobblestones, and rocks at production rates of up to 661 t/h (600 t/h).

With a working width of 7 ft 7 in (2,320 mm) and a maximum working depth of 20 in (510 mm), the Rock Crusher impresses with exceptional performance in all areas of soil stabilization as well as in the processing of a variety of materials.

The robust crushing and mixing unit with HT18 tools developed especially for use in the crushing application and a variable mixing chamber enable the realization of highest efficiency and best mixing results.

The concept of the Rock Crusher allows the simultaneous mixing of binder (and optionally also water) in one pass and thus, during the crushing process.



For soil stabilization in lightly to moderately cohesive soils with a larger content of rocks, the ideal performance range is up to approx. 9,568 yd<sup>2</sup> (8,000 m<sup>2</sup>) per day.

## WIRTGEN COLD RECYCLERS AND SOIL STABILIZERS

### TRACTOR-TOWED STABILIZERS (WS SERIES)

- > Working width up to 8 ft 2 in (2,500 mm)
- > Working depth up to 20 in (500 mm)

### COLD RECYCLERS AND SOIL STABILIZERS (WR SERIES)

- > Working width up to 7 ft 10 in (2,400 mm)
- > Working depth up to 22 in (560 mm)

### ROCK CRUSHER (WRC SERIES)

- > Working width up to 7 ft 7 in (2,320 mm)
- > Working depth up to 20 in (510 mm)

### COLD RECYCLERS (CR SERIES)

- > Working width up to 12 ft 6 in (3,800 mm)
- > Working depth up to 14 in (350 mm)

### MOBILE COLD MIXING PLANT (KMA SERIES)

- > Mixing performance up to 265 t/h (240 t/h)

### LABORATORY EQUIPMENT

# OVERVIEW OF HIGHLIGHTS

## Perfectly Equipped

### 01 Perfect Ergonomics and Operating Comfort

- > Automatic functions that can be individually saved and accessed at the touch of a button for frequently repeated work processes
- > Intuitive operating concept with ergonomically designed, intuitively laid out controls in both arm consoles
- > All important machine functions are logically integrated into the multifunctional joystick
- > Comfortable operator's seat that can be adjusted to different body sizes for productive and fatigue-free work over long periods of time
- > Spacious and comfortable temperature-controlled cabin interior guarantees operator comfort
- > Cabin with ROPS / FOPS standards for maximum operator safety

### 02 Optimal All-Round Vision and a Comprehensive Camera / Monitor System

- > Wide fields of view and generously sized mirrors provide an ideal overview of the construction site
- > Hydraulic, laterally-shiftable cabin and an operator's seat that can be rotated by 90° for a clear view of the entire right-hand working edge
- > Reverse assist system with graphic aids for rapid reverse travel with optimal vision
- > Up to four cameras and an additional monitor on the machine for a complete overview of key work processes and areas
- > Comprehensive lighting equipment for ideal vision when working at night



### 03 Outstanding All-Terrain Capability

- > Field-proven, four-fold full-floating lifting column concept for rapid compensation of unevenness of the ground
- > Electronic cross-slope sensor for adjusting and maintaining the required cross slope
- > Powerful all-wheel drive with intelligently-controlled flow divider (differential lock) for sustained maximum traction

### 04 Efficient Steering System

- > Sensitive electro-hydraulic steering system, combinable with the optional AutoTrac™ steering assistant for absolute precision on the construction site and fatigue-free working
- > Three different steering modes for maximum flexibility on the construction site
- > Minimum turning circle of only 10 ft 4 in (3,150 mm) for fast maneuvering in even the tightest spaces

### 05 WPT Recycling

- > Automatic determination of mixing performance for exact project accounting and analysis of savings potentials

### 06 Efficient Engine and State-Of-The-Art Diagnostic Systems

- > Powerful, state-of-the-art diesel engine ideally suited for sustained heavy work
- > Fully-electronic engine management for reduced diesel fuel consumption
- > High-tech diagnostics technology including maintenance diagnostics, parameter settings, and troubleshooting can be easily accessed via the main display in the operator's cabin
- > Machine equipped with automatic self-diagnostics to automatically monitor valves, sensors, and control components
- > Load-dependent automatic power control to regulate the required machine advance rate

### 07 Heavy-Duty Crushing and Mixing Unit

- > High-productivity crushing and mixing rotor for in-situ applications in the recycling of construction materials and the processing of primary resources
- > Perfect synchronization of engine power, crushing and mixing performance for powerful and efficient operations
- > Particularly heavy-duty, wear-resistant quick-change toolholder system for long and effective working periods and minimum set-up times
- > Nine rotor speeds for optimal adaptation to the subbase resp. soil, the crushing process, and for assuring homogeneous mixing results
- > Variable crushing stage and screening unit with automatic adjustment of the gap distance to the rotor
- > Crushing and mixing unit with wear lining for maximum utilization rates
- > Adjustable scraper plate down-pressure for optimization of mixing result and machine productivity

### 08 Precise Addition of Water

- > Heavy-duty, microprocessor-controlled water spraying system to ensure exact compliance with dosing specifications.
- > **VARIO** injection bar - variable nozzles enable the adjustment of injection pressure
- > Logically structured graphic displays and easily adjustable metering parameters for high-quality mixing results
- > Easy activation and deactivation of individual spray nozzles to vary the spray width
- > Regular, automatic self-cleaning of spray nozzles



# WIDE RANGE OF APPLICATIONS

## High-performance Rock Crusher

The Rock Crusher WRC 240(i) is employed for the processing of base layers in road construction - it is also used in soil stabilization applications for in-situ crushing of rocks contained in various soil types, beds, or layers. This is enabled by the heavy-duty crushing and mixing unit with a working width of 7 ft 7 in (2,320 mm) and a maximum working depth of 20 in (510 mm) designed and constructed especially for these applications. The main task of the WRC is therefore the simultaneous, in-situ granulation and mixing of the material at hand to produce a homogeneous, high-quality final product. The machine can produce at rates of up to 661 t/h (600 t/h).

Binding agents (e.g. cement) and water can be added and

mixed in during the ongoing rock crushing process to prepare a base layer and increase its load-bearing capacity. For this purpose, cement, for example, is pre-spread with a binding agent spreader and the water required is injected into the variable mixing chamber via the **VARIO** injection bar.

In addition to processing tasks in road construction, the WRC is also employed on soil stabilization projects. In the course of this, a pre-spread binding agent such as lime or cement is mixed into the existing soil with insufficient bearing capacity, transforming it in-situ into a high-grade construction material. In this application, a performance of up to approx. 9,568 yd<sup>2</sup> (8,000 m<sup>2</sup>) per day can be achieved in lightly to moderately cohesive soils.

01



In certain application scenarios it is important to reduce only the proportion of cavities and improve the spatial consistency. Here, it may well be sufficient to crush the material in place and mix it without the addition of a binding agent. Granulation / homogenization optimizes the particle grading and distribution within the mix and thus achieves the desired bearing capacity.

The methodology of in-situ recycling shows advantages over material removal and replacement that are reflected in shorter construction times, lower CO<sub>2</sub> emissions, less material trucking, and lower material disposal costs. In addition, perfect ergonomics and all-round vision, high performance and mixing quality, outstanding off-road capabilities, automatic functions, and many other highlights make the WRC a pioneer in terms of high output with low operational costs.

**01** Crushing / granulation with simultaneous mixing of binding agents and water.

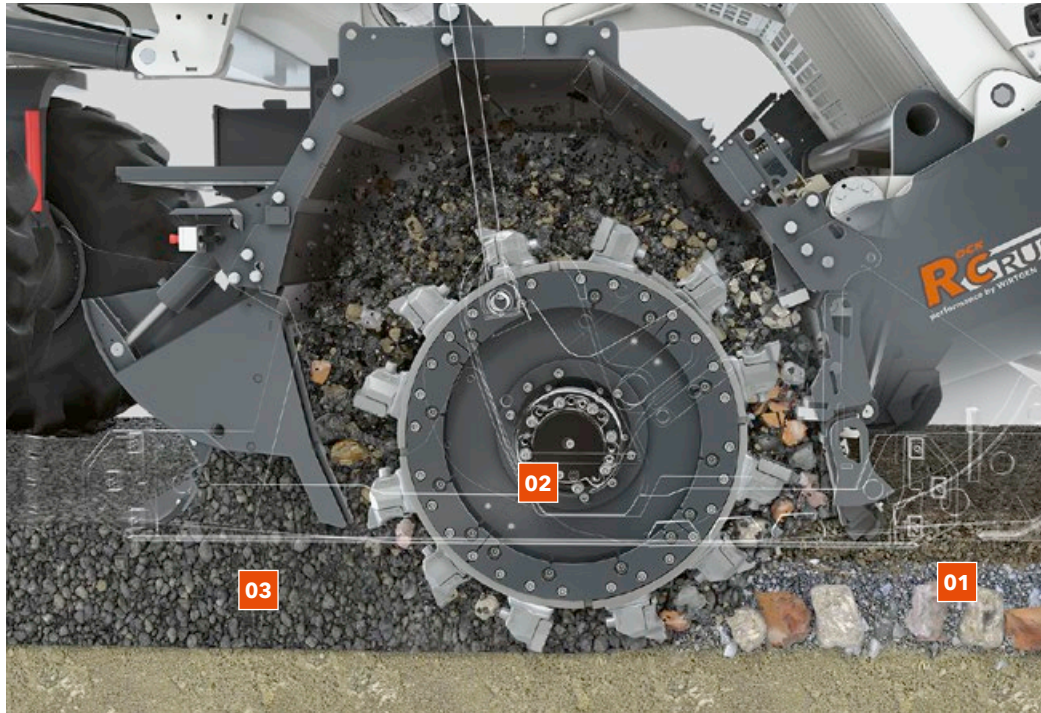

### The Material Processing Concept

- 01** Material containing pieces of rock
- 02** Crushing and mixing unit
- 03** Processed, homogeneously-mixed end product



**02** Initial situation



**03** Crushing and mixing result: assess and if necessary adjust the parameters

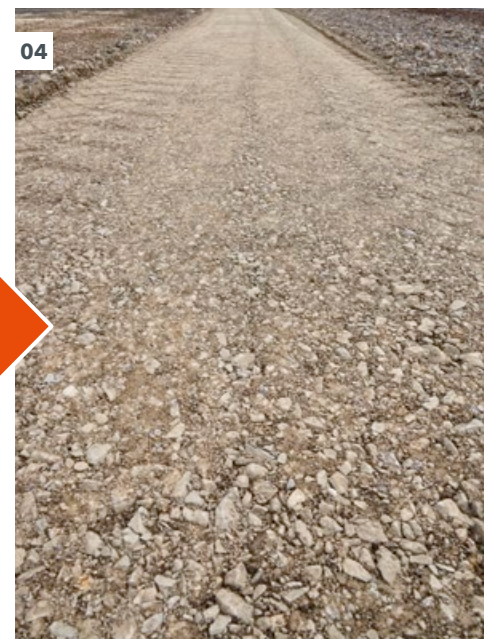

**04** Optimal result after one single pass

# WIDE RANGE OF APPLICATIONS

## Examples of Applications

Range of Applications Rock Crusher WRC 240 (i)

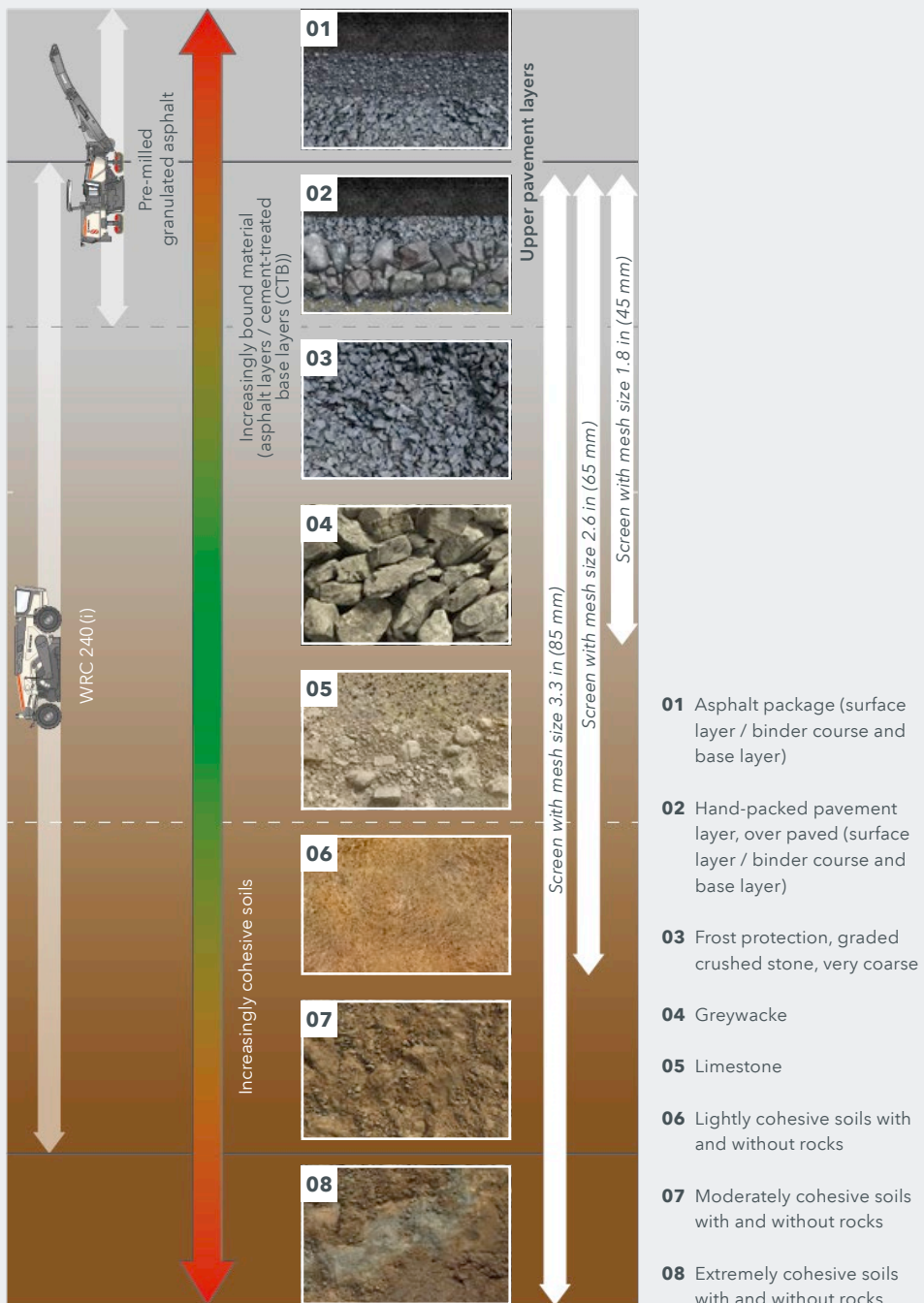

### Primary Application - Road Construction

The first step in the processing of the road surface is the treatment of the surface layer and binder course and, if required, the asphalt base layer, with a WIRTGEN cold milling machine. Depending on the situation, this layer is milled off and removed or can be left in place for mixing with the base layer material to be prepared. The WRC crushes the material in place to a predefined maximum particle size and mixes it to create a homogeneous construction material – if required, pre-spread binding agents and water from the injection bar can also be added during the process.

Above all in road construction, the WRC can be used to produce high-quality base layers from existing hand-packed pavements.

### Secondary Application - Soil Treatment (also Subbases and Subsoil)

The WRC is also used for homogenization and granulation in the stabilization of lightly to moderately cohesive soils with and without rocks. If necessary, pre-spread binding agents can be mixed in simultaneously in a single pass.



### Range of Applications - Working Depths Rock Crusher WRC 240(i)

1. Milling of the surface and binder course with a WIRTGEN cold milling machine

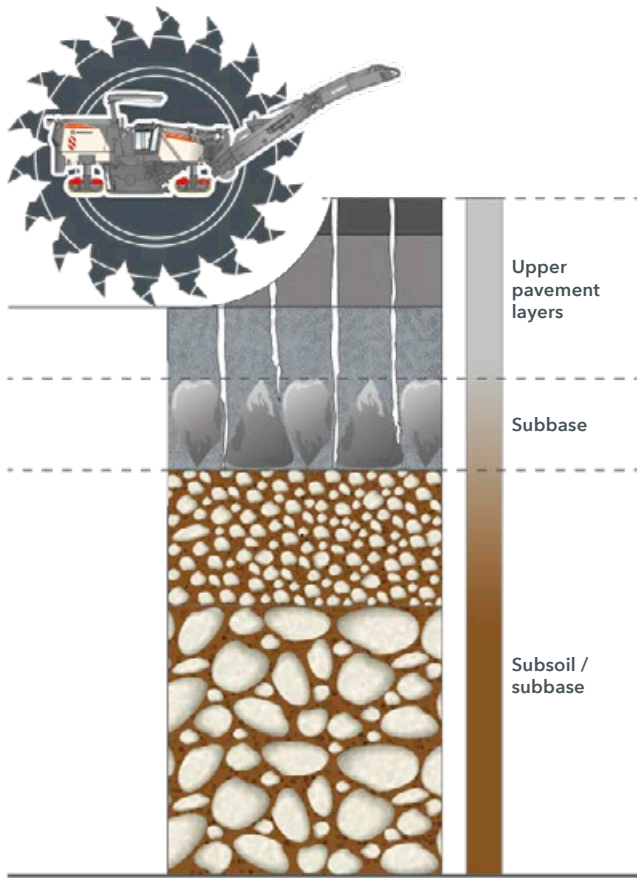

2. Crushing and mixing with the WRC 240(i)

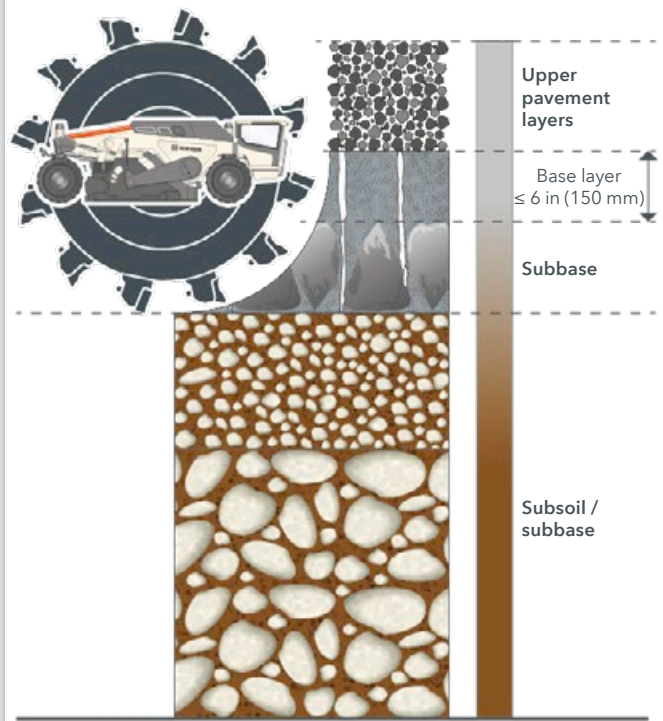

#### Secondary Application - Road Construction and Rock Crushing

The WRC is used for processing and the crushing of rocks in the areas of road building, maintenance of forestry roads and landfill sites, and in quarries.

Essentially, the WRC is used for the granulation of rock material with edge sizes of up to 12 in (300 mm) and a compressive strength of up to 29,008 psi (200 MPa).

# WIDE RANGE OF APPLICATIONS

## Granulation of Unbound Base Layers, Hand-Packed Pavement Layer, and Subbases

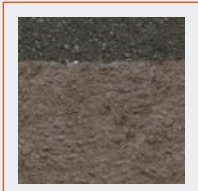

If necessary, the asphalt layers are milled off separately by a WIRTGEN cold milling machine and left in place prior to the granulation of unbound base layers, hand-packed pavement layer, and subbases. The Rock Crusher WRC 240(i) then granulates the material in-place without

the addition of binding agents. While a John Deere grader carries out the fine profiling of the processed, homogeneous construction material, various rollers from HAMM perform the required compaction.



Compactor



Motor grader



Compactor

## Granulation and Stabilization of Unbound Base Layers, Hand-Packed Pavement Layer, and Subbases with Cement and Water



Before the granulation and stabilization of unbound base layers, hand-packed pavement layer, and subbases with cement and water, the upper surface layer and the binder course are first separately milled by a WIRTGEN cold milling machine. This is followed by a Stremaster binding

agent spreader that spreads small quantities of cement, and a water tanker. At the rear of this train, the powerful crushing and mixing rotor of the Rock Crusher WRC 240(i) following on behind granulates the damaged layers.



Compactor



Motor grader



Compactor



Rock Crusher

## Granulation and Stabilization with Cement and Water in Road Construction



For granulation and stabilization with cement and water in road construction, a Stremaster binding agent spreader lays down small amounts of cement and is followed by a water tanker. The Rock Crusher WRC 240(i) then follows on and granulates the material in-place. As it advances, it

simultaneously mixes in the pre-spread cement and the water applied via the injection bar. While a John Deere grader carries out the fine profiling of the processed, homogeneous construction material, various rollers from HAMM perform the required compaction.



Compactor



Motor grader



Compactor

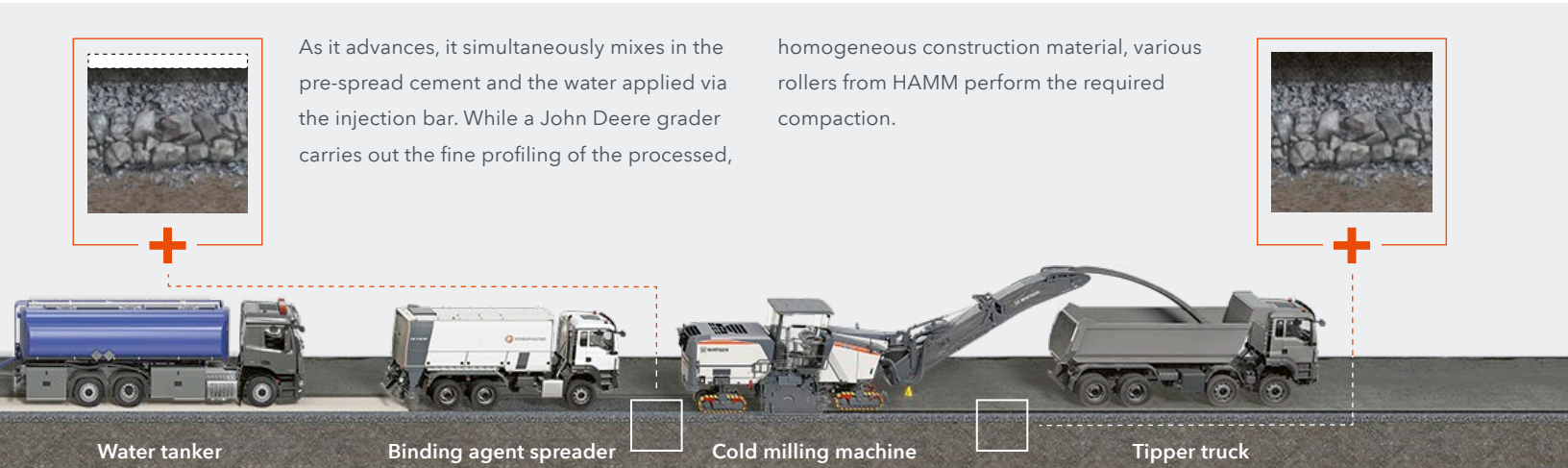
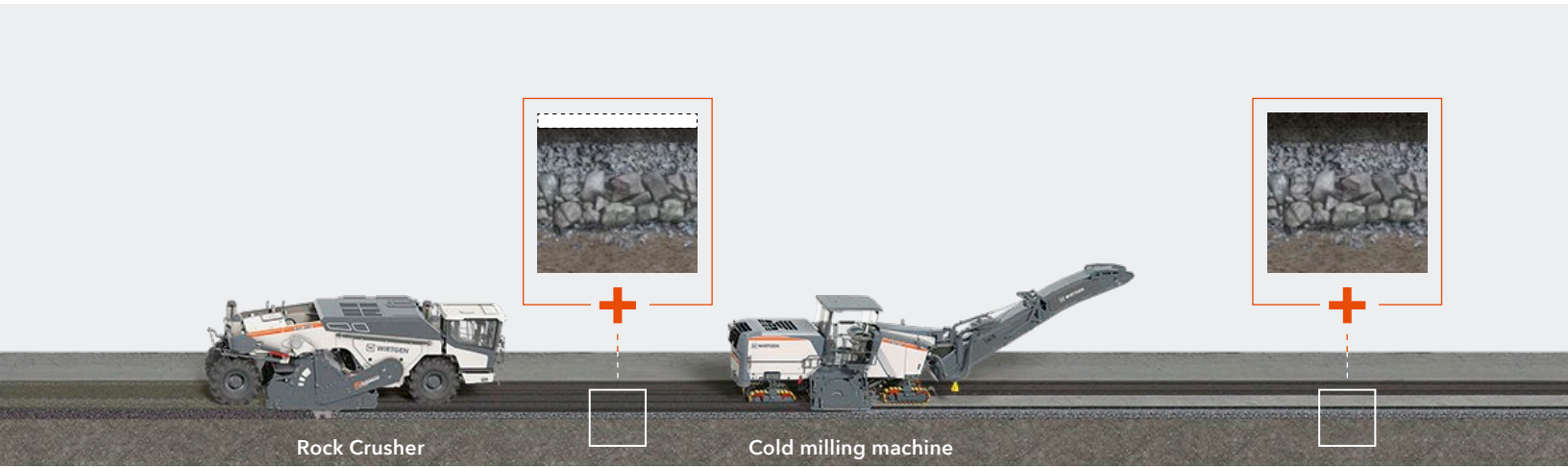

# WIDE RANGE OF APPLICATIONS

## Homogenization or Granulation of Lightly to Moderately Cohesive Soils with and without Rocks



For the homogenization or granulation of lightly to moderately cohesive soils with and without rocks, the Rock Crusher WRC 240(i) granulates and loosens up the soil in place without the addition of a binding agent.

While the John Deere motor grader profiles the homogeneous soil mixture produced in this way, various rollers from HAMM perform the required compaction.

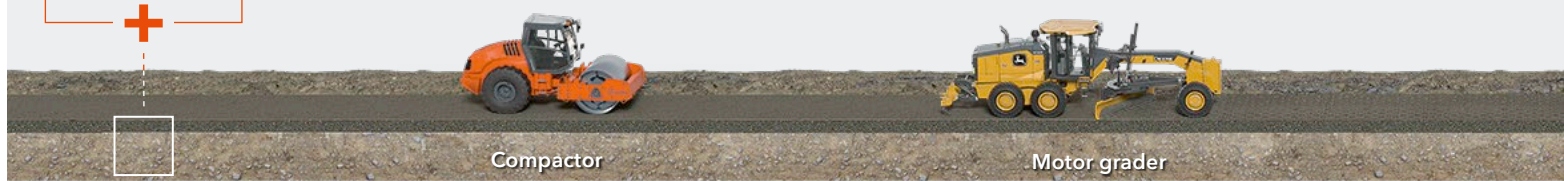

Compactor

Motor grader

## Stabilization of Lightly to Moderately Cohesive and/or Stony Soils with Lime or Cement

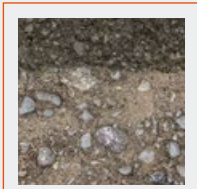

For the stabilization of lightly to moderately cohesive soils with and without rocks with lime or cement, the Streamaster binding agent spreader lays down a previously defined quantity of binding agent. The Rock Crusher WRC 240(i) follows on behind the binding agent spreader and granu-

lates and homogeneously mixes the soil to be processed with the pre-spread binding agent. While a John Deere grader carries out the fine profiling of the homogeneous soil mixture produced in this way, various rollers from HAMM take care of the required compaction.



Compactor

Motor grader

Compactor

## Crushing Fractured Rock in Quarries

For the crushing of fractured rock in a quarry, the Rock Crusher WRC 240(i) granulates and loosens up the ground in place. Wheel loaders following behind the WRC 240(i) take up the material and transport it away for further processing.

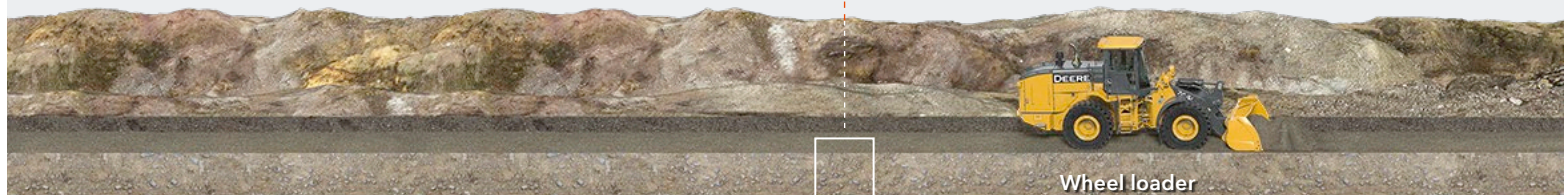

Wheel loader

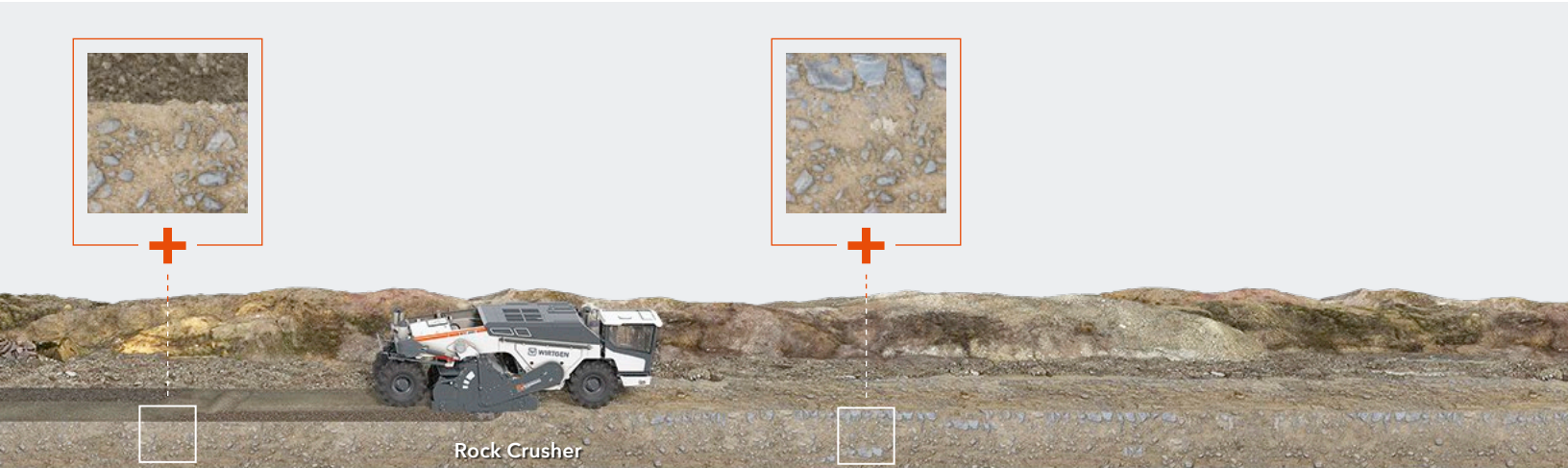
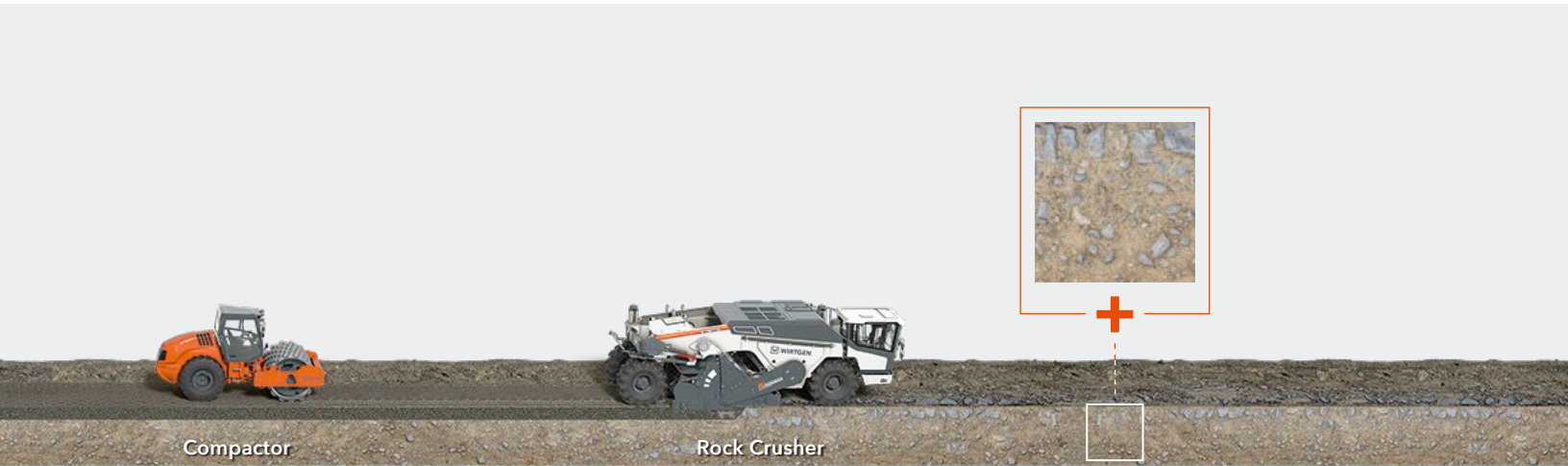

# COST-EFFICIENT METHOD

Conventional Process for the Recycling of Hand-Packed Pavement Layers



## Cost-Effective and Ecologically-Optimized Method for the Processing of Construction Materials

The WRC 240(i) is designed for the crushing or granulation, processing and homogenization of hand-packed pavement layers, concrete fragments, cobblestones, and rocks - and that in-situ.

The processing or transformation of the said materials in place to achieve a load-bearing subbase and upper pavement layers

by conventional construction methods generally requires comparably enormous effort and a long construction process. The milling process is followed by the excavation and transportation of the material to a landfill site or a mobile crushing plant for further processing or recycling. After the transportation of the new or recycled material back to the construction site, the next step of the process is paving with the new material all over again.

### Granulation of Unbound Base Layers, Hand-Packed Pavement Layers, and Subbases



### Granulation and Stabilization of Unbound Base Layers, Hand-Packed Pavement Layers, and Subbases with Cement and Water



With the WRC 240(i), the material in place can be granulated in-situ. A maximum particle size is defined on the basis of the machine settings and the choice of screens resp. mesh size. Although classified screening is not possible in this in-situ process, it does allow cohesive materials with rock content to be granulated, homogenized, and mixed in.

If required, the WRC 240(i) can also mix in a pre-spread binding agent (e.g. cement). In addition, water from a tank truck can be sprayed in with the **VARIO**- injection bar and mixed - and all this in just one single operation.

In short: This innovative method is characterized by short construction times, the deployment of fewer machines and vehicles, resource-friendly operations, and a considerable reduction of CO<sub>2</sub> emissions.

At the end of the day, it enables savings of over 60% of the construction time for corresponding projects and a reduction of CO<sub>2</sub> emissions by over 80%.

**Over 60%**  
Shorter Construction Times

**Over 80%**  
Lower CO<sub>2</sub> Emissions

**Up to 100%**  
Less Material Trucking

**Up to 100%**  
Lower Material Disposal Costs

# APPLICATION-SPECIFIC MACHINE DESIGN

Comparison of the WRC 240(i) and the WR Series

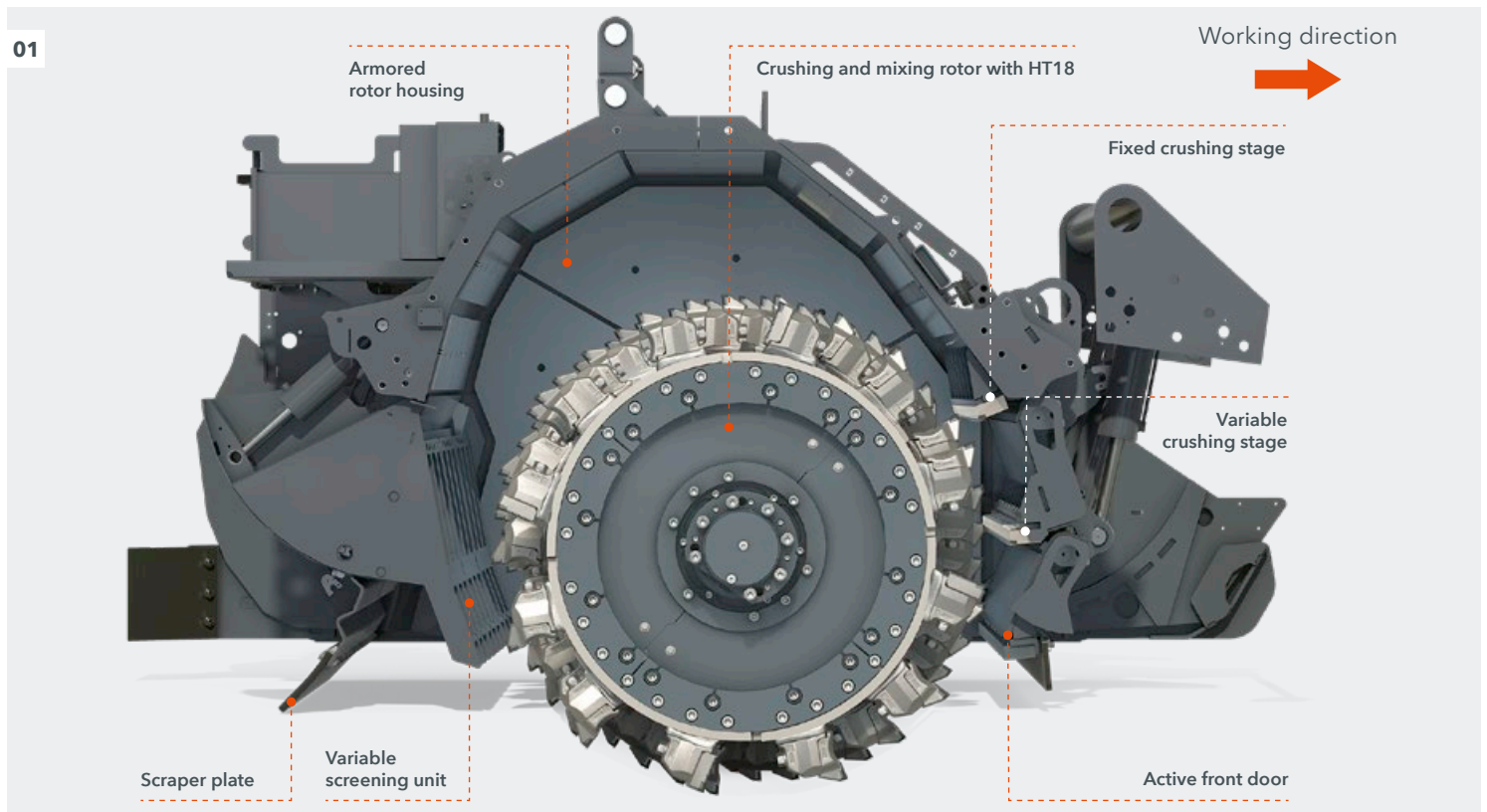

The WRC 240(i) can be optionally fitted with a water injection bar. This means that the WRC 240(i) can mix in pre-spread binding agents and water in the same way as the WR Series models. The machine design concept of the WRC 240(i) therefore makes it the ideal choice for a wide range of applications and guarantees high machine utilization rates. Consequently, there are also a number of identical capabilities within the range of applications.

With regard to the crushing and mixing application, the WRC 240(i) differs from the machines of the WR Series in one particular respect; it is neither designed nor constructed for milling applications. This means that it is suitable for the processing of bound layers only under certain conditions and after appropriate preparatory measures. The WRC 240(i) performs granulation, crushing, and mixing in a single process.

The following lists the particular characteristics of the WRC 240(i):

## Heavy-Duty Crushing and Mixing Unit Impact-Resistant Crushing And Mixing Tools

The special crushing tools with extremely impact-resistant and resilient carbide plates throw the material to be crushed against the two crushing stages.

## Variable and Fixed Crushing Stages

With their carbide cutting edges, the crusher bars of the fixed crushing stage and the variable crushing stage serve the purpose of the counterblades required in a crushing process. This decisively influences the particle sizes of the crushed resp. granulated material.



**Active Front Door**

The front door seals off the crushing and mixing unit at the front. It also enables to actively push in materials and rocks.

**Screens with a Range of Mesh Sizes**

A selection of exchangeable screens with different mesh sizes allow only material already crushed to the desired particle sizes to be passed out of the crushing and mixing unit. A scraper plate behind the unit smooths off the material. Should the WRC 240(i) be used only for homogenization or mixing in binding agents, the variable screening unit can be rigidly connected to the scraper plate. In floating position, the scraper plate-screen combination profiles the mix and guarantees homogeneity. The pressure of the scraper plate in floating position can be hydraulically increased or reduced from the machine's control panel.

**Armored Rotor Housing**

In order to ensure that the forces developed in the crushing process and the large pieces of rock don't lead to deformation or rapid wear of the rotor housing, all surfaces are additionally lined with extremely wear-resistant steel plates.

**High-Performance Rotor Drive**

The rotor gearbox with active cooling developed especially for crushing applications enables the higher rotor rotation speeds that are essential for the achievement of homogeneous crushing and mixing results.

# MACHINE SETTINGS

## Optimal Crushing And Mixing Results

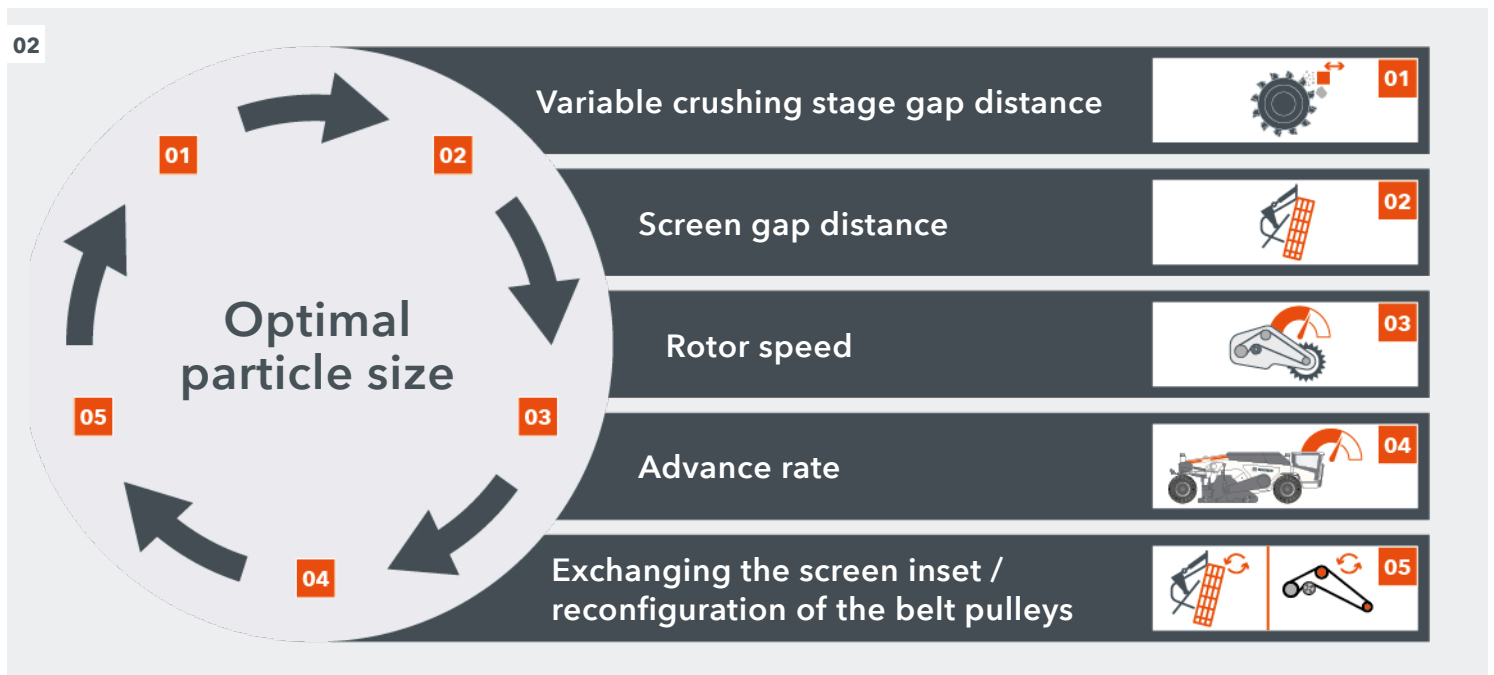

At first, it is advisable to work with the adjustable machine parameters such as the gap for the variable crushing stage, the gap distance for the screen unit, the machine advance rate, and the engine speed, which, in turn, determine the rotation speed of the crushing and mixing rotor.

The first few meters will enable the determination of whether the crushing and mixing result is satisfactory. Should the adjustable variables not immediately deliver the desired result, the belt pulleys and the screens should be adjusted to meet the specified requirements.

# PERFECT ERGONOMICS AND OPERATING COMFORT

## Space and Comfort Are the Keys to Success

This is why we've paid so much attention to the operator's workplace. The WRC's spacious, soundproofed cabin has plenty of room to move around and a comfortable, temperature-controlled interior. A comfortable operator's seat, a high-performance air-conditioning and heating system, a radio with CD

player, a compressed air connection, an-air gun for cleaning the cabin, backlit controls, and numerous storage options are just a few of the many features. They make the operator's work easier by increasing physical comfort and performance, and thus increase the overall productivity of the machine day after day.



**Take a Seat and Enjoy the Comfort**  
Jumbo-size state-of-the-art operator's cabin

**Everything under Control**  
Intuitively Laid Out Control Elements

### Ergonomics - Reinvented from the Ground Up

The ergonomic highlight of the WRC is the anatomically shaped operator's seat with spring and air damping. It can be adjusted to fit different body sizes and guarantees that the operator can sit comfortably for many hours at a time. In addition, both arm consoles have ergonomically shaped controls built in - their convenient layout guarantees intuitive operation.

- 01** Intuitively laid out controls and the fully-adjustable operator's seat in the spacious cabin offer perfect ergonomics and comfort.
- 02** The multifunctional joystick on the right-hand arm console fits perfectly into the palm of the operator's hand.

For ease of operation, the controls for all the machine's key functions have been logically grouped in the multifunctional joystick on the right-hand arm console. The entire operator's seat, including the arm consoles and steering column, can be rotated by 90° to either side, ensuring that the operator has an ideal overview of the area behind the machine while maintaining a relaxed posture.



**03 - 04** The individually adjustable comfort seat enables the operator to find the most comfortable working position.

# PERFECT ERGONOMICS AND OPERATING COMFORT

## The WRC Makes Work Easier - Day after Day

These days, the pressures of completion deadlines on construction sites mean that contractors can no longer suspend their work due to adverse weather conditions, darkness, or the onset of night. This is where our intelligent lighting concept comes into its own. The WRC features the following lighting equipment: six floodlights on the front of the cabin (optionally available with LEDs), two headlights each on the left and right sides, two cornering lights at the rear, and two spotlights with magnetic mounts that can be positioned anywhere on the machine.

It enables operations to continue in full swing even after the sun has set. "Welcome-and-go-home" lighting function When approaching or leaving the WRC, the function lights up the area around the operator's cabin with LED lamps. And safety always comes first - when working on the engine or cooling system, side handrails can be folded up in just a couple of simple steps. The cabin complies with ROPS / FOPS standards, offering maximum protection for the machine operator.



**01** The operator can easily access the spacious cabin.

**02** Transportation is possible with all standard low-loader trailers.

**03** The comprehensive lighting system fully illuminates all of the machine's main working areas.

**04** Automatic end-of-cut function: the crushing and mixing rotor and the front and rear scraper plates are moved to the preset position. When the WRC is reversed, the rotor is raised and complete closes the cut at the end of the strip.

**Higher Performance at the Press of a Button**

The WRC is equipped with a smart automatic system that takes control of the lowering and raising process.

The operator activates the automated process on the multi-functional joystick and the WRC takes care of everything else: First of all, the machine is swiftly lowered. The active front door moves to its nominal position and the crusher bars and the automatic screening system move to the preset gap distance in relation to the crushing and mixing rotor. At the same time, the scraper plate is set to floating. All nominal values can be freely selected and set. When the lifting columns are lowered into their

working position, the crushing and mixing rotor penetrates into the ground down to the programmed working depth.

The operator then moves the joystick forward and the machine begins to advance. The automatic end-of-cut function - activated by the joystick - closes the cut at the end of each strip in the rotor area.

While the WRC travels a few meters, a rotor plate completely closes the cut. At the same time, the rotor is lifted slowly and the lifting columns move the machine into transport position.

**Fast and Efficient**

Savable Automatic Functions

**Fast Relocation to Next Job**

Compact Transport Dimensions

04

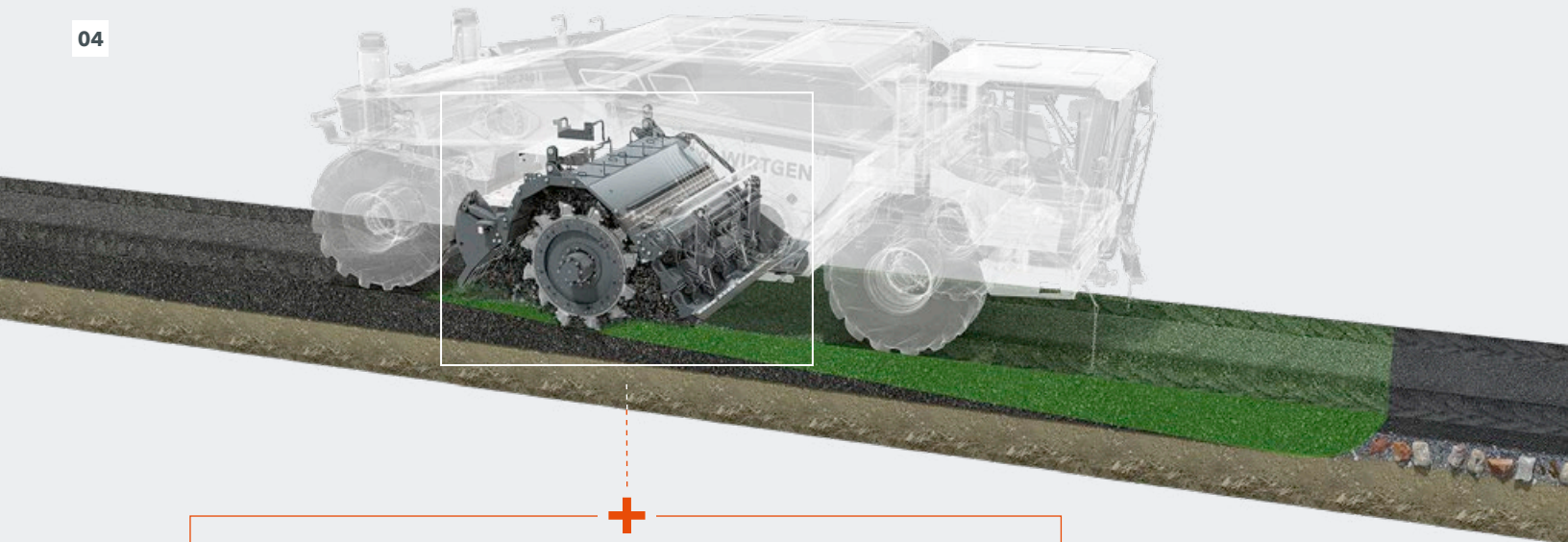

Direction of lifting out



# OPTIMAL VISIBILITY AND COMPREHENSIVE CAMERA SYSTEM



**Overview of the Entire Construction Site**

Smart all-round vision concept

**Keep Sight of the Zero Edge**

Laterally Shiftable Operator's Cabin

**Enhanced Visibility Enhances Productivity**

Good visibility is critical to safe operations and rapid processes. The WRC offers a visibility concept that is unique in the industry: Large glass windows on the left, front, and right sides of the cabin as well as practical mirrors provide an excellent overview of the entire job site. The spacious operator's cabin can be moved to project over the edge of the machine on the right and the operator's seat can be rotated by 90°, offering an unobstructed view of the entire working edge on the right side.

These features make it easy to work flush to the edge without requiring time-consuming follow-up work.

Thanks to the excellent view of the entire working edge on the right side of the machine, recycling operations can be carried out with maximum precision right at the edges of road surfaces. The clear view of the right working edge also makes exact overlaps possible.

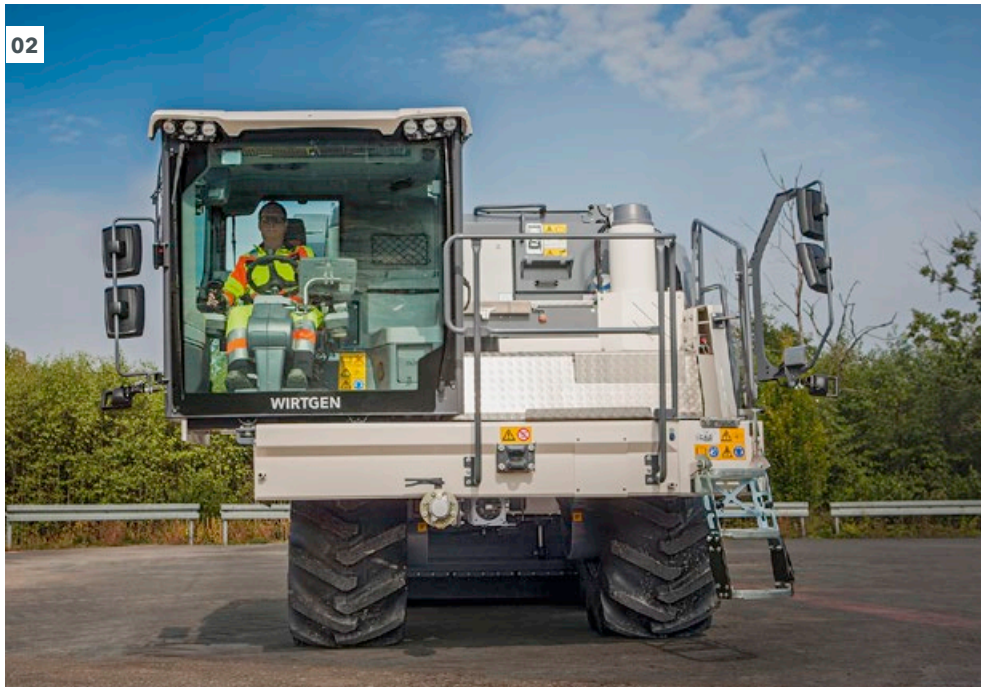

**01 - 02** The operator's cabin can, for example, be hydraulically shifted far to the right to enable the operator to see past a recycling train working ahead of the machine.

# OPTIMAL VISIBILITY AND COMPREHENSIVE CAMERA SYSTEM

01



**Perfect Overview of All Important Work Processes**  
Multi-camera monitoring system

**Collision Avoidance System**  
Reverse Assist



02



Camera, left side of machine



Camera, rear area



Camera, rear drum flap



Camera, front drum flap

### Second-To-None Camera System

Camera systems are increasingly becoming an important tool for monitoring operations and processes on machines where excellent visibility is essential. Even the base version of the WRC comes equipped with a rear view camera.

The intelligent reverse assist system supports the machine operator when reversing by displaying driving assistance lines.

The machine can even be equipped with a system consisting of a total of four color, high-resolution cameras - at the rear of the machine, on the left-hand side of the machine, and underneath the machine at the front and rear rotor plates - at the customer's request. If multiple cameras are used, an additional screen is installed to display the camera images.

Keeping an eye on important work processes and areas, such as approaching obstacles or examining the results, significantly increases performance, cost-effectiveness, and quality.

**01 - 02** Four cameras and the reverse assist system provide a perfect overview of the working area and maximum operator comfort.

# OUTSTANDING OFF-ROAD CAPABILITY

## Stable Handling and Ample Ground Clearance

The WRC easily negotiates even the most uneven surfaces while maintaining its horizontal alignment at all times. The machine's automatic four-way full-floating axle and electronic cross-slope sensor are key features when it comes to maintaining machine stability and balance. With the help of the sensor, the WRC can operate parallel to the surface or at the specified cross slope. The tried-and-tested, four-way full-floating lifting column design quickly and dynamically compensates for any uneven ground.

It ensures that the milling and mixing rotor maintains the desired depth on both the left and right side, ensuring precise working results. The height of the wheels can be adjusted to the left, right, front, or rear in pairs in order to fully adapt the machine to the respective site conditions. When moving sideways across sloping terrain, the operator can use the "roll" feature to adjust the machine to a more comfortable horizontal position. This means the operator also benefits - by being able to work in a relaxed manner while enjoying a comfortable ride.



**Moderately Cohesive Soils Are No Problem at All**

Traction is the magic word when it comes to high-performance stabilization in any type of soil. And the WRC has more than enough of that. Extra-large, high-grip tires effectively transfer the power of the high-performance engine to the ground. The tough bite of the all-wheel hydrostatic drive system continuously delivers maximum traction to each of the independently-driven wheels. The automatic power control governs the machine advance rate dependent on the load. Depending on the site conditions, the hydraulic flow divider (“differential lock”) is activated to achieve maximum traction in even the most challenging terrain.

When ample ground clearance is required in deep, muddy soils, the automatic height adjustment of the four-fold full-floating axle concept really comes into its own. The travel speed can be infinitely adjusted from standstill to maximum speed in both working and transport modes.

The bottom line: The WRC is the ideal machine for mixing in binding agents on difficult ground.

<p><b>High Machine Stability</b> Four-fold pendulum axle system</p>	<p><b>Optimal Traction</b> All-Wheel Drive</p>
---	--

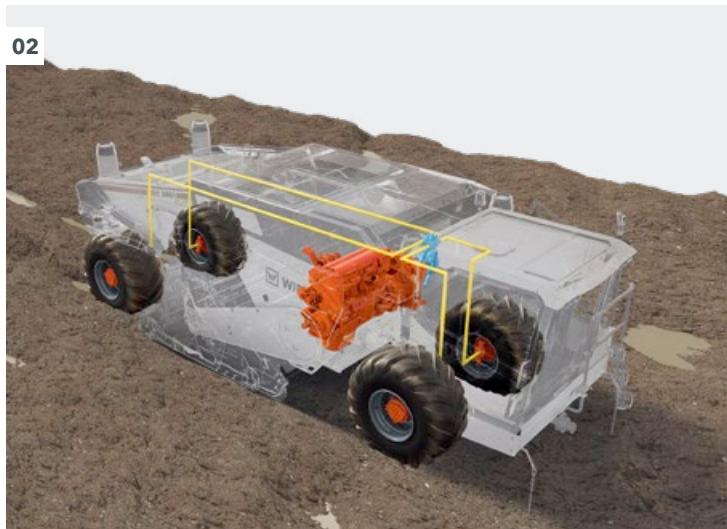

**01** Even deep, wet ground is no problem at all with all-wheel drive.

**02** The all-wheel drive system distributes the drive power evenly to all four wheels.

**03** The WRC compensates for ground unevenness without difficulties.



**03** The WRC compensates for ground unevenness without difficulties.

# PRECISE, SATELLITE-BASED AUTOTRAC™ STEERING SYSTEM

Thanks to the SF-RTK correction signal, the GNSS satellite-based steering system steers the machine with an accuracy within tolerances of a few centimeters (+/- 1 in (2.5 cm) from strip to strip) on the basis of a previously calculated reference strip and a specified overlap of adjacent strips. Working with the system couldn't be easier.

First of all, the machine is driven along a reference strip, which the system saves and stores. This is displayed on the separate 10" control screen supplied with the system and can be interactively adjusted as required. In the next step, the machine operator selects the desired strip overlap, positions the machine in the next strip and activates AutoTrac™. The system now precisely steers the machine with an optimal strip overlap and assures consistent utilization of the machine's ideal working width.

If one considers the sum of the large, avoidable overlaps with neighboring strips that can occur in manual operations, the potential savings the system can bring soon become clear. The project can be completed faster, with lower consumption of fuel and other consumables, and, as a result of this, a reduction of CO<sub>2</sub> emissions. And all of this hand-in-hand with optimal quality of the finished result and a reduction of the operator's workload.

In combination with WPT, the WIRTGEN GROUP Performance Tracker, the AutoTrac™ steering system can save up to 10 % of the resources otherwise required for the job.



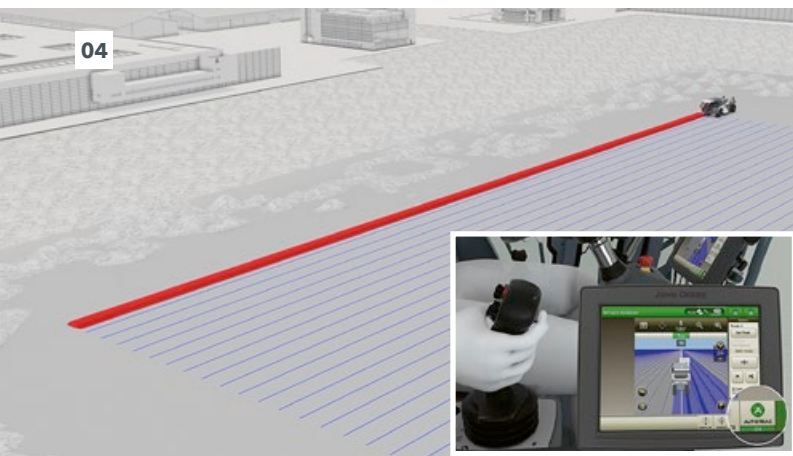
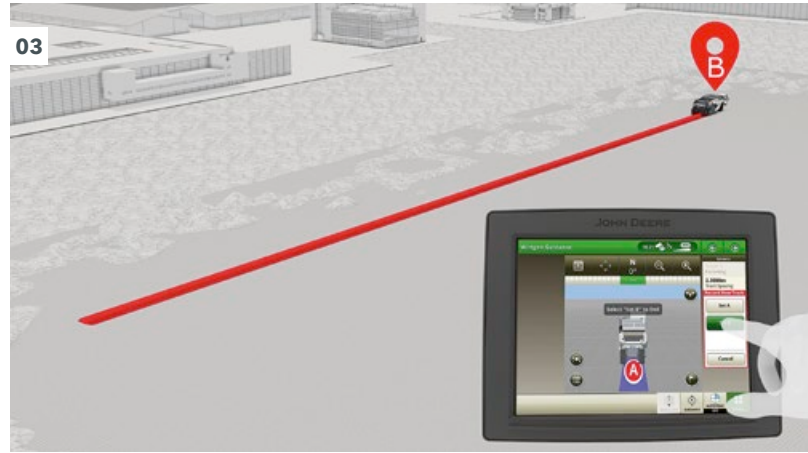

**01** Typical surface, e.g. in manually controlled soil stabilization without predefined overlap..

**02** The operator completes one strip...

**03** ... and saves it as a reference strip that can then be copied as often as necessary. The operator selects the desired overlap and starts AutoTrac™.

**04** The operator starts AutoTrac™ by pressing the button on the joystick.

**05** The system now precisely steers the WRC with an optimal, predefined strip.

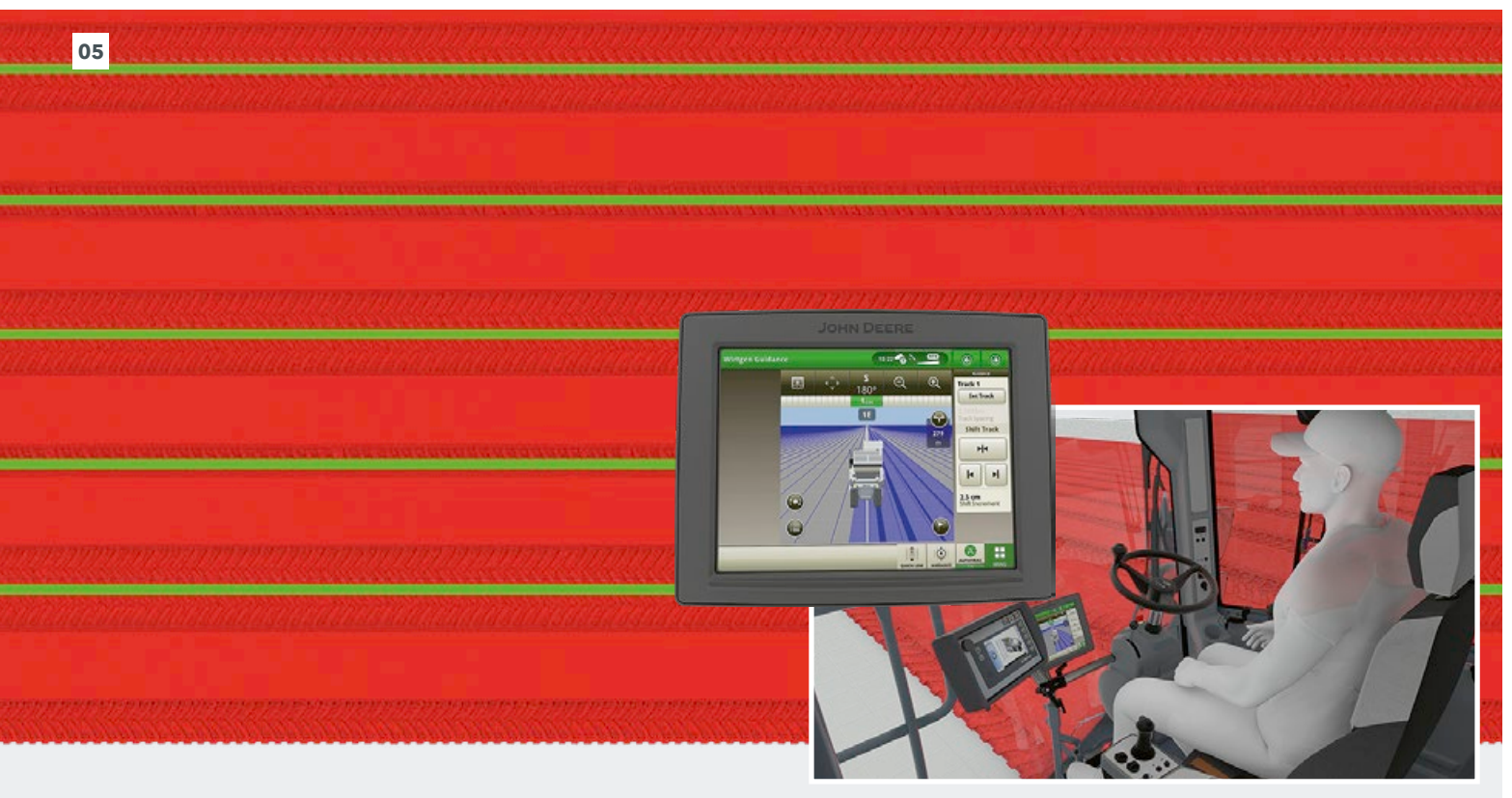

**05**

# FIELD-PROVEN STEERING SYSTEM

## Fast Maneuvering in Tight Spaces

Thanks to its electrohydraulic “steer-by-wire” steering system, the WRC has everything it needs for smooth, even steering. The operator can choose from three different steering modes: straight-ahead, crab steering, or cornering. Each of the three steering modes is the fastest way to reach the destination in its specific area of application. In cornering mode, the WRC achieves the minimal turning radius of 14 ft 9 in (4,500 mm). The steering wheel’s innovative oversteering feature allows the rear wheels to be turned even further, in which case the WRC

can even achieve an extremely tight turning radius of 10 ft 4 in (3,150 mm). As a result, it even surpasses the very tight turning radius of ordinary passenger cars. The operator can easily switch between the steering modes using the multifunctional joystick, and the currently selected steering mode is always clearly visible. The sensitive steering and the freedom to select the steering mode help make the operator’s job easier. This not only allows them to more effectively focus on delivering top quality results, but also makes them much more productive.

## Precise and Effortless Control

Sensitive steering response

## Turning Circle Only 10 ft 4 in (3,150 mm)

Smart Steering System

01



**01** The extremely small turning circle enables rapid turning maneuvers in even the tightest spaces.

**02** Different steering modes for particularly easy handling. In cornering mode, the operator can also oversteer the rear axle and achieve an extremely tight turning circles.

**02**

Working direction  
→

**Straight-ahead mode:**

The operator steers the front wheels with the steering wheel.



In this mode, the rear wheels automatically remain locked in the straight-ahead position, but can be steered separately using the joystick.

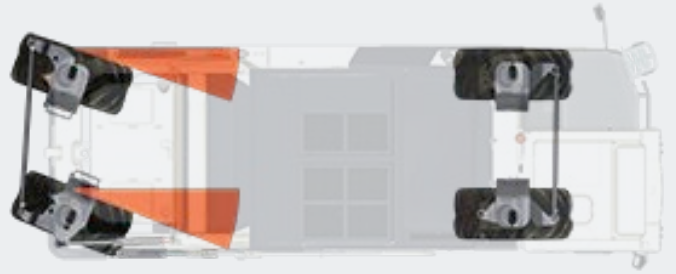

**Crab steering mode:**

All four wheels are steered at the same angle simultaneously via the steering wheel.

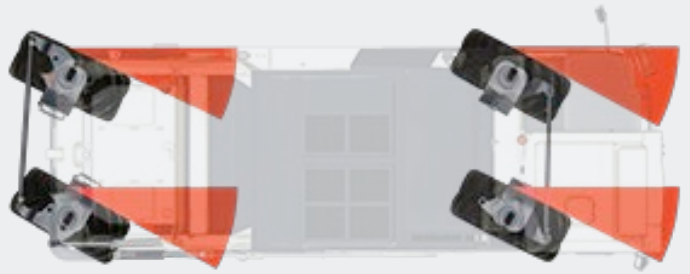

**Cornering mode:**

The front and rear wheels are steered in sync using the steering wheel, making tight turning circles possible.

**Cornering mode - with oversteering:**

The front and rear wheels are steered in sync with the steering wheel, enabling tight turning circles.

When a certain steering angle is reached, the rear wheels can be turned even further via the steering wheel. Oversteering makes even tighter turning circles possible.

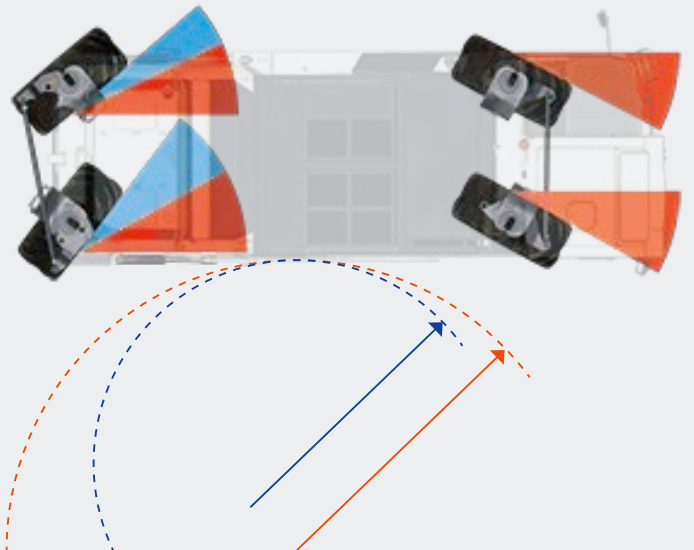

--- = Minimum turning circle in cornering mode:  
 $R_{min} = 14 \text{ ft } 9 \text{ in (4,500 mm)}$

--- = Minimum turning circle in cornering mode with oversteering:  $R_{min} = 10 \text{ ft } 4 \text{ in (3,150 mm)}$



# WPT RECYCLING

High-Precise WIRTGEN GROUP Performance Tracker Recycling

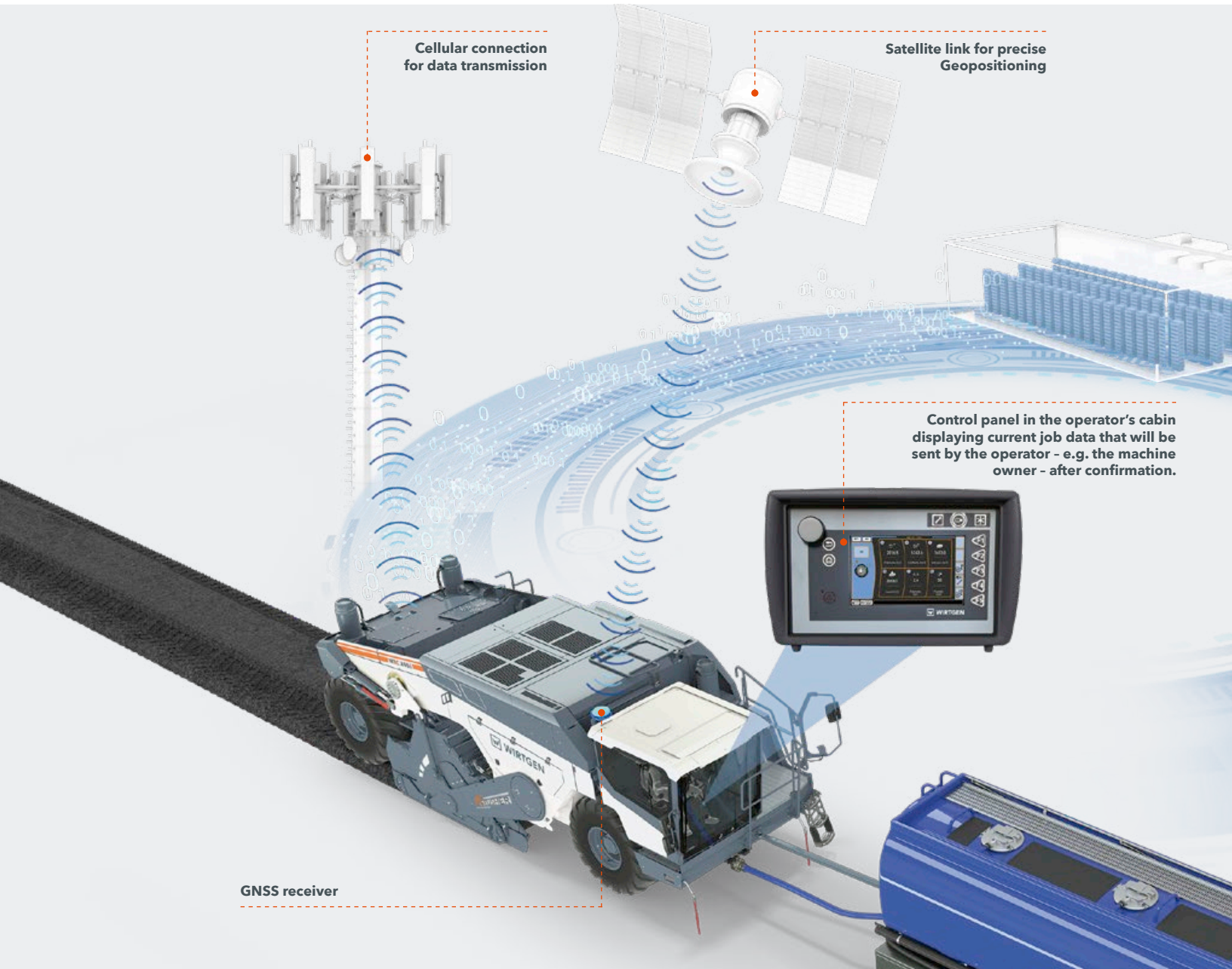

**Automatic Mixing Performance Tracker**  
Precise WPT Recycling

**Analysis of Saving Potentials**  
Accounted Consumption Of Resources



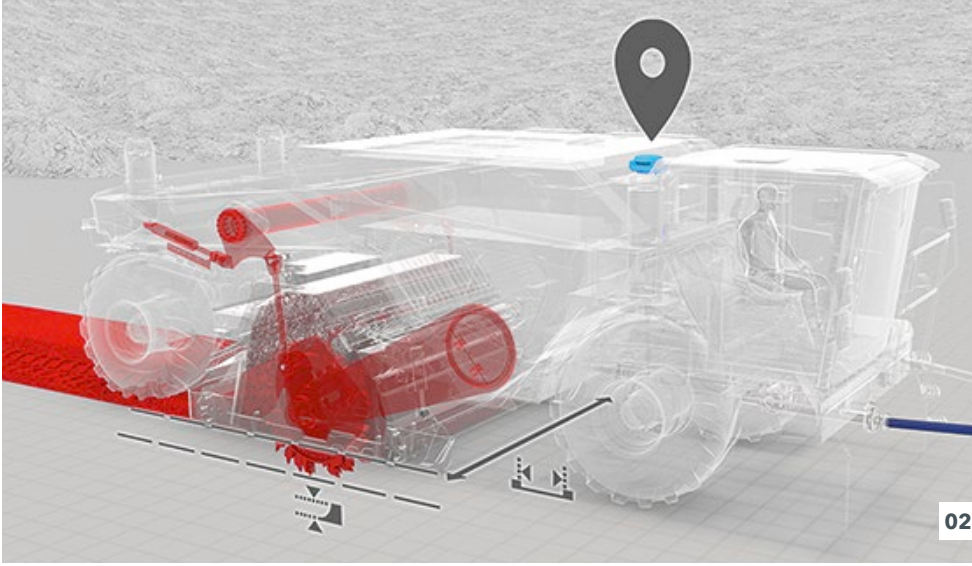

**01** The operator receives constant information about the current machine and job parameters - at the end of the working day, the data is transmitted to the machine owner simply by pressing a button.

**02 WPT** Recycling precisely determines the area and volume performance and the additive quantities with the aid of satellite-based positioning data and the high-precision sensor system on the machine.



**01**

### Precise Mixing Performance Tracking

WIRTGEN GROUP Performance Tracker Recycling is a satellite-positioning-based monitoring and tracking system for precise documentation of construction sites. It records all site-specific parameters and documents them as a detailed field report. After completion of the work (e.g. the end of the working day), the machine operator presses the send button to transmit the data to the WITOS server via the telematic control unit (TCU) of the mobile communication interface. From there, the data are distributed to the designated recipients, e.g. in the form of a report by e-mail.

The GNSS receiver with the licensed SF-RTK correction signal enables accuracy in the range of 1 in (2.5 cm) from strip to strip, and this with a very short signal pull-in time. This enables the documentation of extremely accurately located machine information immediately after the day's work begins, i.e. as soon as the machine is started.

In addition to high-precision GNSS machine position data, the report contains various parameters such as the working width and depth, the distance and area covered, the addition of water and binding agents, and consumption figures for items such as diesel fuel, and picks. In addition a separate layer file in PDF format shows the respective working depths and the precise-locations at which water and binding agents were added.

The results enable a precise analysis of performance on the construction site, the quality of the results delivered, and the process efficiency. This in turn enables detailed accounting of all processes and the identification of future savings potentials. At the same time, at the end of each shift, the resource planner receives reliable and precise documentation of performance and progress on the construction site without any additional effort.

# EFFICIENT ENGINE AND STATE-OF-THE-ART DIAGNOSTIC SYSTEMS

## Superior Engine Technology

The WRC's state-of-the-art, high-torque diesel engine is perfect for soil stabilization and cold recycling operations requiring maximum performance. But in addition to the muscle, it also uses its "brains" - the intelligent, fully electronic engine management system optimizes engine performance, maintained torque at a constantly high level, even in the event of extreme engine lugging. Ample torque reserves mean that nothing stands in the way of further increases in power output, if required. In addition, automatic speed adjustment reduces diesel consumption.

## Rapid On-Board Diagnostics

State-of-the-art measuring technology is by far superior to conventional, manual measuring methods. We have therefore equipped the WRC with high-tech diagnostic systems that allow maintenance diagnostics, parameter settings, and troubleshooting to be performed effortlessly via the control panel in the operator's cabin. The machine's automatic self-diagnostic system autonomously monitors valves, sensors, and control components. Numerous clearly visualized pages provide quick and accurate information on the machine's current operating parameters.

01



**Constantly Monitored Machine Status**

High-Tech Diagnostic Systems

In addition, extended servicing intervals and an intelligent maintenance concept minimize maintenance requirements. The handful of service points are clearly arranged and easily accessible either from the ground or via ladders.

In short, the WRC has been designed for maximum operational availability.

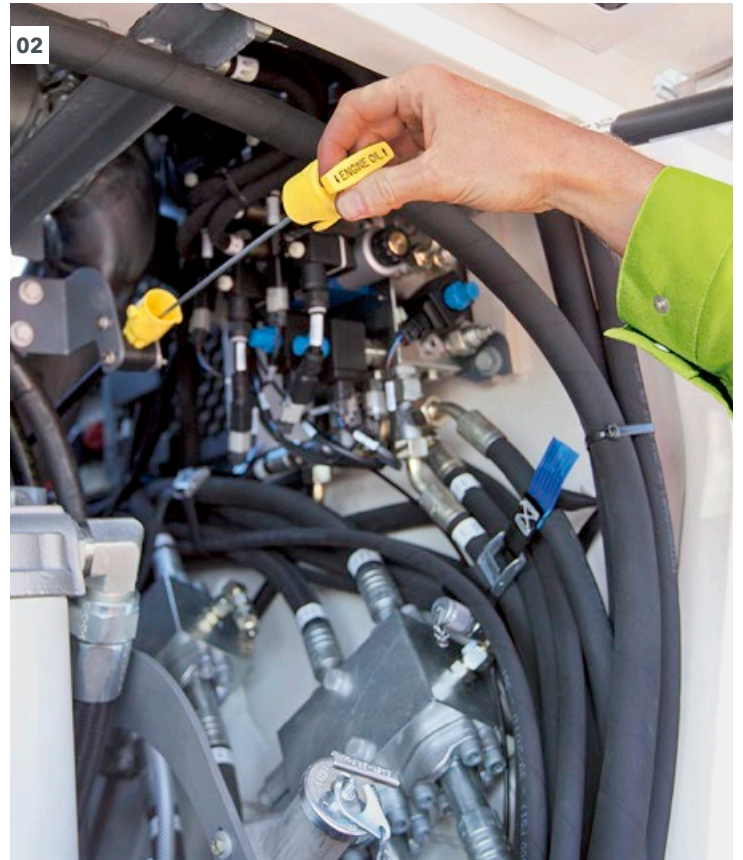

**01** Diagnostics and parameter settings are performed via the control display.

**02** The oil level can easily be checked from the ground.

**03** When opened, the engine cover offers easy access to the engine compartment, hydraulic system, air system, air filter, and pumps.

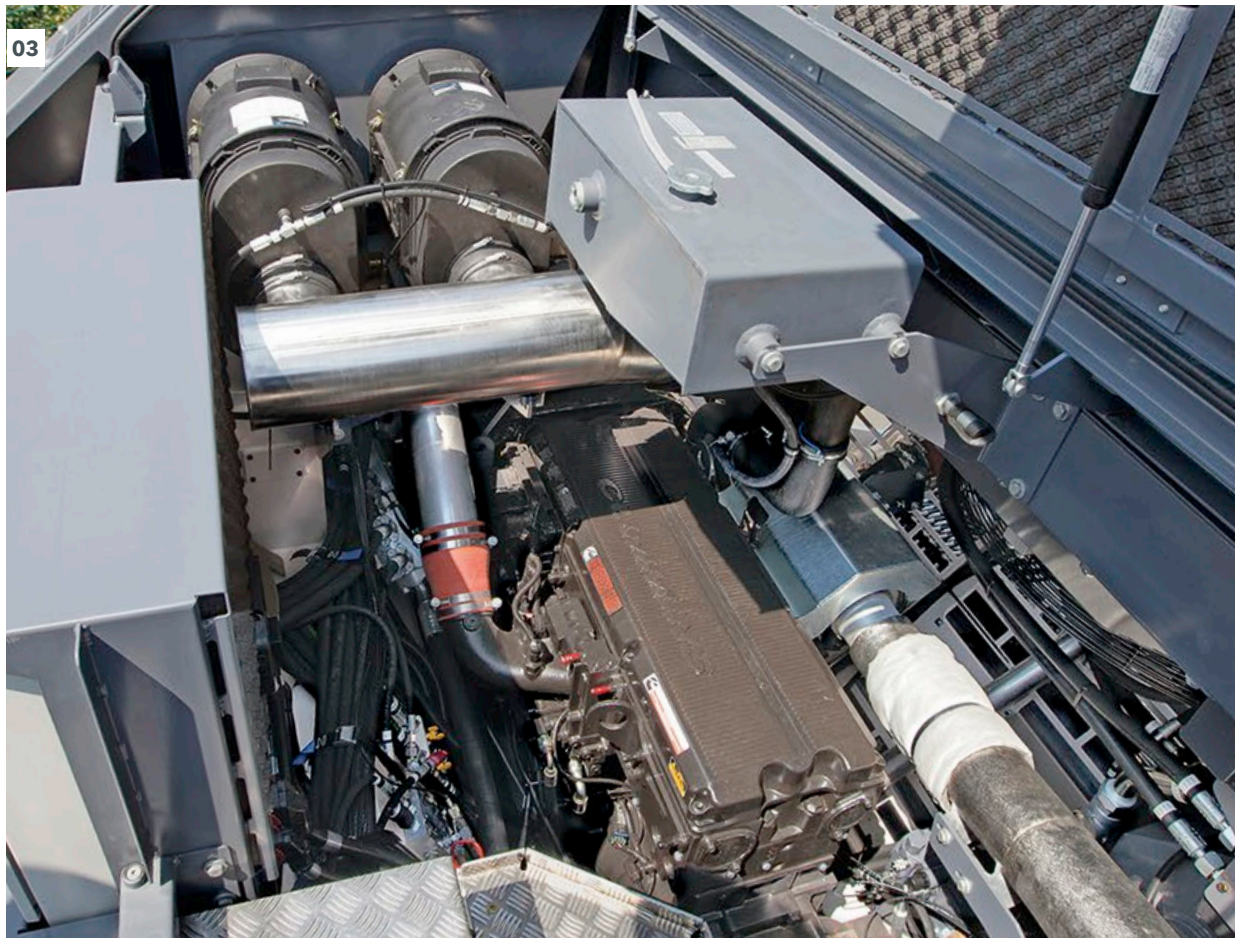

# HEAVY-DUTY CRUSHING AND MIXING UNIT

Rugged and Resilient Crushing and Mixing Rotor

## Highlights of the Crushing and Mixing Rotor

**01 Universal Crushing and Mixing Rotor**  
> High-productivity crushing and mixing rotor for in-situ applications in the recycling of construction materials

**02 High Operational Reliability and Utilization Rates**  
> Impact-resistant crushing tools for demanding crushing and mixing applications  
> Heavy-duty HT18 quick-change toolholder system for minimal machine downtimes

**03 Extremely High Mixing Performance**  
> Intelligently designed holder base geometry paired with the large diameter of the crushing and mixing rotor ensures maximum productivity

**04 Best Mixing Results**  
> Tool spacing and tool configuration precisely tailored to machine performance to ensure best mixing performance  
> Ideally arranged crushing tools for a smooth and even crushing and mixing process

**05 Heavy-Duty Construction**  
> Generously dimensioned wear protection for maximum service life of end ring segments

**06 Heavy-Duty Edge Protectors**  
> Wear and fracture resistant edge protectors developed especially for crushing applications

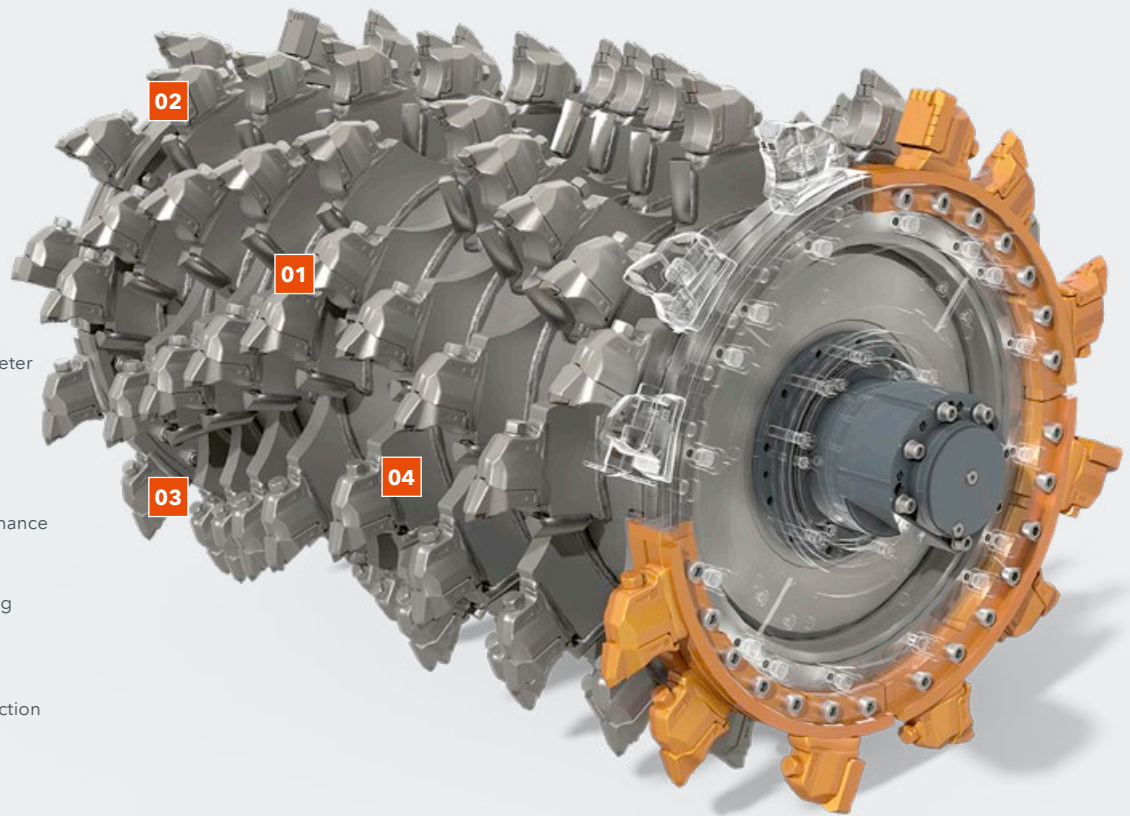

### The Heart and Soul of the WRC 240(i) - The Ultra Heavy-Duty Crushing and Mixing Rotor

Cutting technology is our core strength: The extremely wear-resistant crushing and mixing rotor of the WRC transforms not only rock dispersed soils into homogeneously mixed, compactable material. It is also ideal for the granulation of hand-packed pavement layers to create a new, highest-quality base layer in road construction. The intelligent design of the rotor makes it ideal not only for crushing, but also makes it possible to mix in binding agents in the same pass without any problems.

**07 Four Support Segments**

Four integrated support segments for the dissipation of extreme stresses

**08 Easy Replacement of the robust End Ring Segments**

Good accessibility of the bolted-on end ring segments for quick and easy replacement with installed rotor

01

The performance of Rock Crusher's engine, crushing and mixing system are ideally matched to one another. The heavy-duty rotor construction promotes smooth rotation without jolts or shocks, thereby reducing wear and tear on the drive elements.

The crushing tools with solid bases are ideally arranged up to the edges of the rotor to guarantee homogeneous mixing of the construction materials at any working depth and also provide resistance to even the highest stresses.

The hydraulic drum rotation device moves the rotor into the ideal position to enable the operator to exchange the crushing tools with a minimum of effort. In addition, the wear-resistant quick-change toolholder system and tools specially optimized for the crushing process guarantee long and effective working periods.

**01** Highlights of the crushing and mixing rotor.

**02** The crushing and mixing rotor ensures high mix quality.

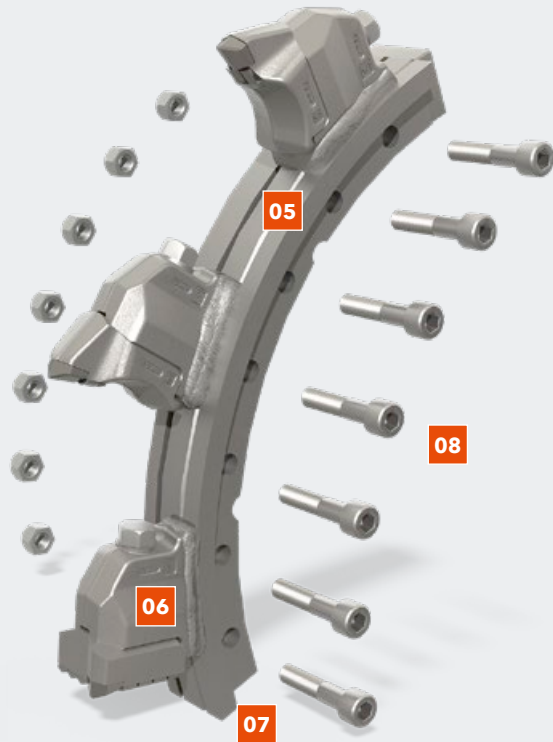

# HEAVY-DUTY CRUSHING AND MIXING UNIT

## Impact-Resistant Crushing And Mixing Tools

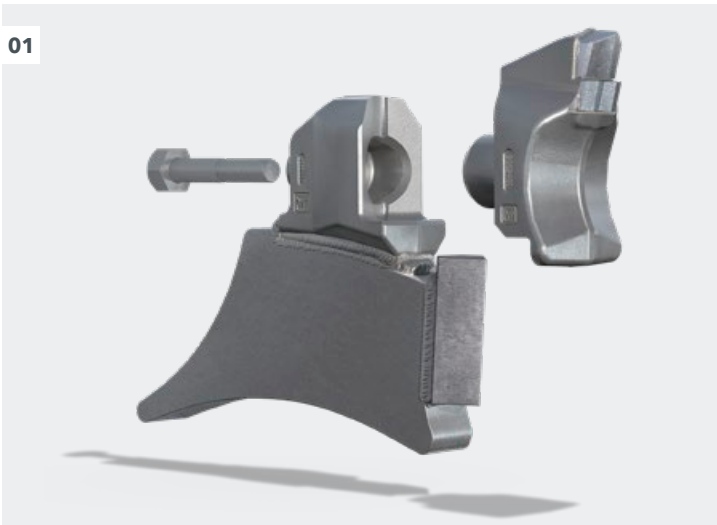

01 Crushing tools HT18 in detail.

### Rugged and Resilient Crushing Tools

The forged and hardened crushing tools with the solid HT18 quick-change toolholder system interface are specially designed for high productivity, universal crushing applications. The resilient HT18 toolholder bottom parts are welded onto extremely wear-resistant bases. In combination with the selected material, the chosen base geometry enables optimal dissipation of the acting forces in the crushing and mixing process.

The geometry of the WRC crushing tools with a generously dimensioned carbide cutting edge guarantees enormous impact resistance and ensures reliable crushing and granulation in a wide range of materials. At the same time, the ideal configuration of the crushing tools guarantees a smooth and even crushing and mixing process.

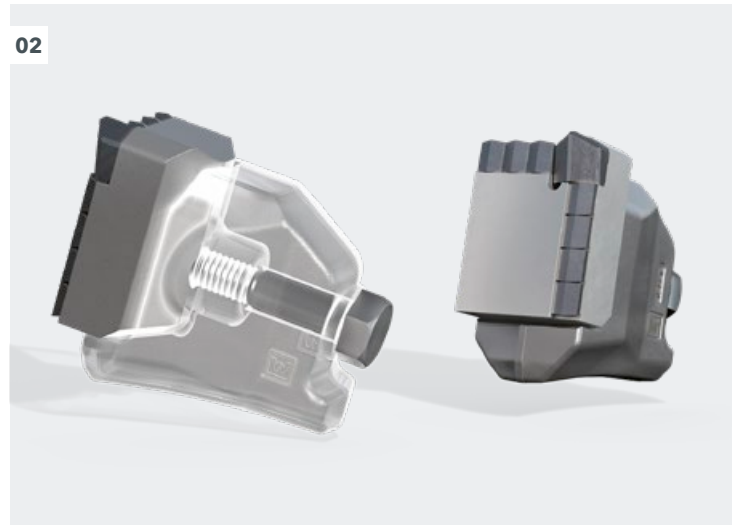

02 Edge protector HT18 in detail.

In the helix area, an extremely wear and impact resistant edge protector is installed on each end ring segment alongside the WRC crushing tools - also with an HT18 toolholder interface. The different geometry of the edge protector is designed to provide wear protection for the front face of the crushing and mixing rotor.

All tools are also positioned in a way that enables operator-friendly maintenance and quick and safe exchange of the crushing tools.

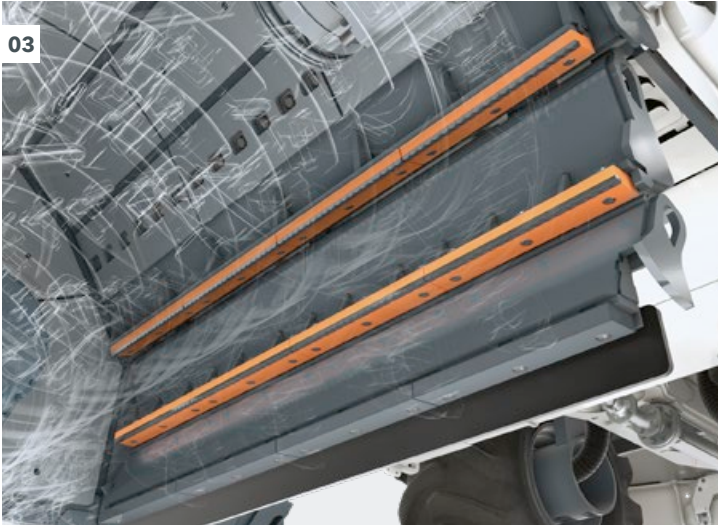

**03** The carbide-edged crusher bars of the fixed and variable crushing stage act as counterblades that work in unison with the HT18 crushing tools and enable the rock to be crushed.

### Variable and Fixed Crushing Stages

The WRC is equipped with a fixed and a variable crushing stage. Both crushing stages act as counterblades that work with the HT18 crushing tools. Four identical crusher bars are bolted onto each of the crushing stages. These are fitted with heavy-duty carbide cutting edges like those of the HT18 crushing tools. Thanks to their additional form-fit connection, these can easily absorb peak loads.

The first, the variable, crushing stage can be adjusted manually or by means of an infinitely variable automatic function. Here, the machine control system ensures that the gap between the crusher bars and the crushing tools is always set to a value that eliminates the risk of them colliding when lowering the rotor. The gap between the rotor and the crushing tools can be set in automatic mode. The gap distance will then also be maintained when the working depth is changed - if necessary, the machine control system will automatically readjust the gap distance. This means that the desired particle size can be maintained at all working depths.

The second, fixed, crushing stage is a non-adjustable "bottle-neck" that forms a single entity together with the rotor housing and additionally protects the spraying zone of the crusher bar against wear. The positioning of this crushing stage ensures that the rotor cannot come into contact with the crusher bar, even at its upper end position. The combination of both crusher stages delivers an optimal crushing and mixing result with maximum efficiency.



**04** Coarse rocks build up in front of the active front door. **05** The active front door is opened manually and the material is pushed into the crushing and mixing housing as the machine advances. **06** The active front door is closed to minimize the ejection of material towards the front.

### Active Inlet Flap

The inlet flap acts as a seal for the crushing and mixing housing. This can be manually set to meet all requirements by the machine operator, but demands active intervention on the part of the operator. In the event of material bursting out or rolling forward, it can be pressed back into the housing by opening the inlet flap and closing it again. The inlet flap is also manufactured from high-tensile steel.

# HEAVY-DUTY CRUSHING AND MIXING UNIT

## Wear-Resistant Construction

### Screens with a Range of Mesh Sizes

The high-tensile steel screen inserts are mounted in a hydraulically adjustable frame construction. They allow only material crushed to a particle size determined by their mesh size to be passed out of the crushing and mixing housing. The screen unit can be adjusted manually or by means of an infinitely variable automatic function in the same way as the variable crushing stage. Here, the machine control system ensures that the gap between the screen unit and the crushing tools is always set to a value that eliminates the risk of them colliding when lowering the rotor.

In automatic mode, the gap distance will then also be maintained as defined when the working depth is changed - if necessary, the machine control system will automatically readjust the gap distance. The material will be able to pass from the crushing and mixing chamber as soon as it has the required particle size. The scraper plate responsible for even distribution of the material is located behind the screen unit.

The different screen inserts to be used depends on the material in place.

01



02



03



### 01 Screen with a mesh size of 1.8 in (45 mm)

suitable for:

- > non-cohesive materials
- > e.g. gravel, crushed stone, concrete fragments

### 02 Screen with a mesh size of 2.6 in (65 mm)

suitable for:

- > Rock dispersed materials with only lightly cohesive content
- > e.g. mixtures containing sand, silt, and rocks (such as gravel, limestone etc.)

### 03 Screen with a mesh size of 3.3 in (85 mm)

suitable for:

- > Rock dispersed materials with a high proportion of cohesive material and water
- > Stabilization with a high proportion of rocks
- > e.g. mixtures containing sand, silt, small amounts of clay, and rocks (such as gravel, sand, limestone, greywacke etc.)

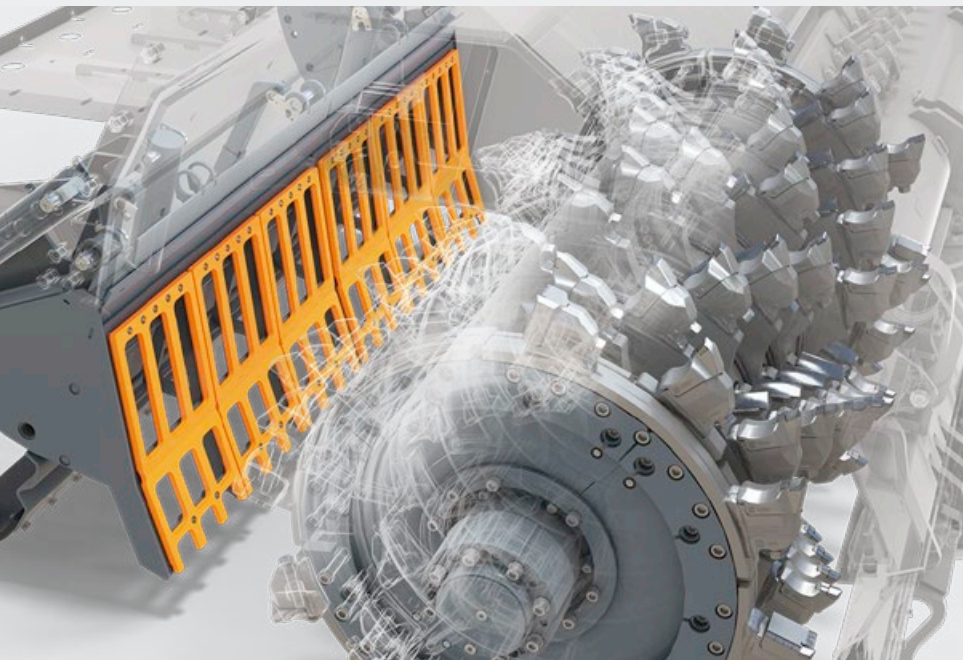





**01** Armored rotor housing for higher utilization rates and increased stability.

### Armored Rotor Housing

The rotor housing of the WRC 240(i) is designed and constructed to withstand continuous extreme loads and stresses. In order to ensure resistance to sustained high loads and stresses when crushing rock, the housing is lined with abrasion-resistant wear plates manufactured from extremely wear-resistant steel.

This in turn increases the service life and overall stability of the housing. Single heavy-duty wear plates can be replaced separately whenever required.

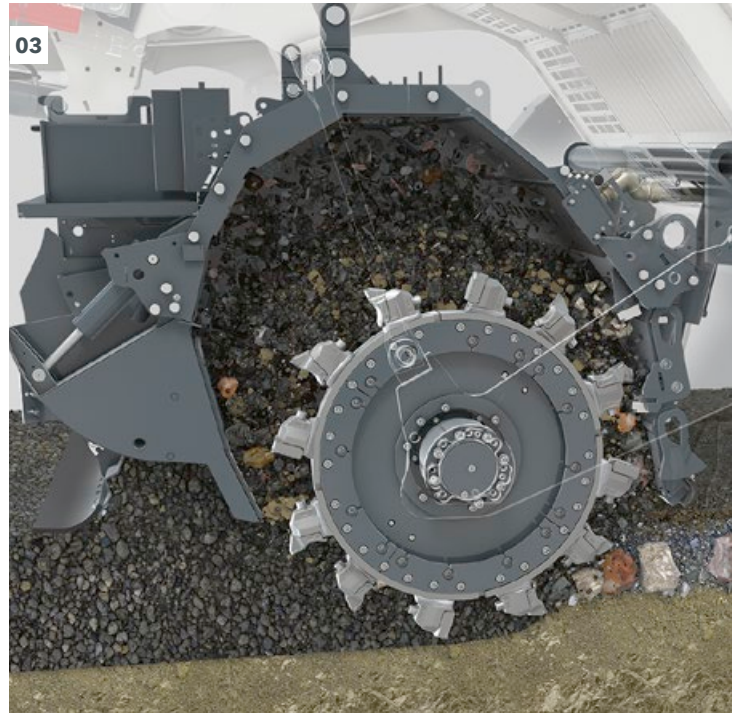
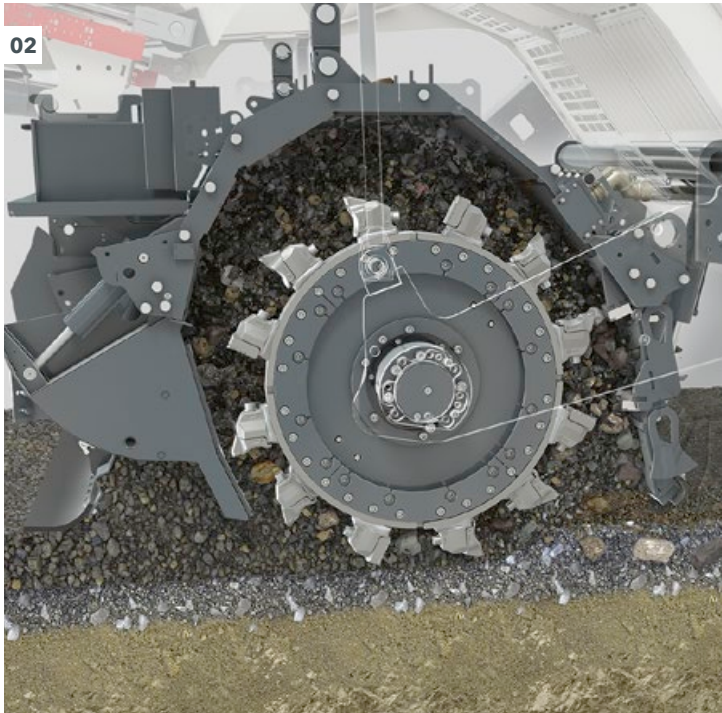

**02 - 03** To guarantee optimal mixing results, the WRC 240(i) features a variable mixing chamber like that of the WR Series models.

### Variable Crushing and Mixing Chamber

The rotor housing and flaps have been designed to perfectly match the performance of the powerful milling and mixing rotor. At the same time, the crushing and mixing chamber volume adjusts to the current working depth and material volume automatically by raising or lowering the rotor. The size of the variable mixing chamber increases with the working depth, thus ensuring maximum performance and outstanding mixing results, even when operating at the maximum depth.

These features enable the machine to produce perfectly homogeneous mixes from the material in place and the added binding agents. In addition, the mix is optimally conveyed within the rotor housing, which significantly increases the material throughput, the mixing quality and the productivity. The active front door and the scraper plate at the rear act as seals for the mixing chamber, guide the material flow, and screed and smooth the deposited layer.

# HEAVY-DUTY CRUSHING AND MIXING UNIT

## High-Performance Rotor Drive

### High-Productivity, Efficient Drive

The WRC 240(i) features a direct mechanical drive that translates high engine power into equally high crushing and mixing performance. The innovative rotor gearbox was developed especially for demanding crushing applications. The extraordinarily high rotor speeds required for the crushing process lead to extreme stresses in the form of friction in the gearbox.

The correspondingly high temperatures of the gearbox components and the gear oil are counteracted by active cooling. At the same time, highest peak loads can be absorbed without any problems. The gearbox concept with active cooling guarantees maximum utilization rates and operational reliability.

**01** Active cooling of the rotor gearbox for high utilization rates.

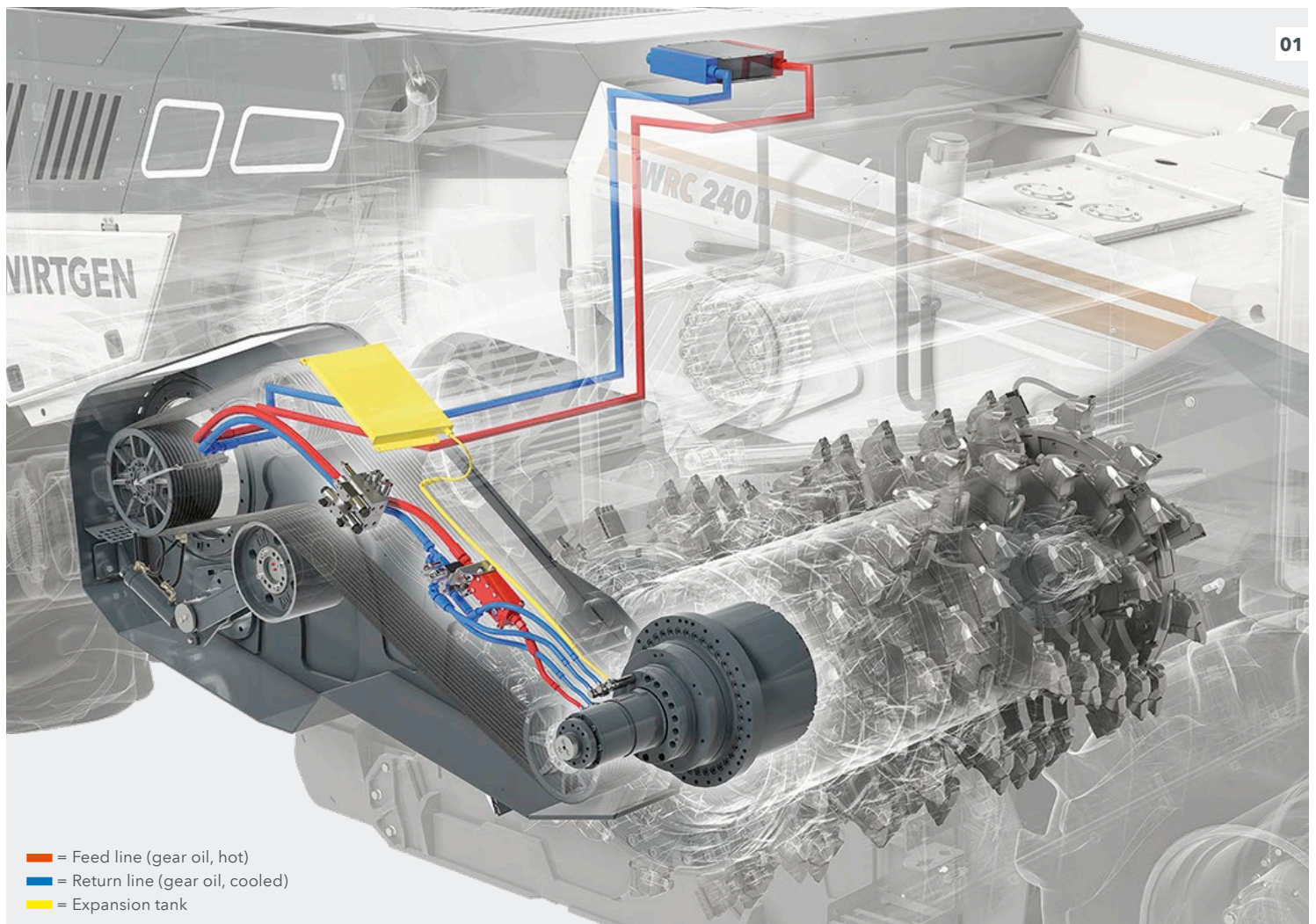

Thanks to the large wrap angle with the V-belt pulleys, the heavy-duty drive belt transmits the engine power to the rotor gearbox with minimal power loss (slippage), thus ensuring high efficiency. Welcome side effects of the intelligently-designed drive concept are low fuel consumption and easy maintenance.

In addition, three different engine speeds can be selected via the right-hand arm console in the operator's cabin and, in combination with the repositioning of the V-belt pulleys, nine different rotor speeds. With the correct rotor speed setting for the respective application, the WRC achieves the desired crushing and mixing results at the highest possible advance rate and with the lowest possible fuel consumption.

Engine speed	Ø 16 in (400 mm) Ø 12 in (315 mm)	Ø 12 in (315 mm) Ø 14 in (355 mm)	Ø 14 in (355 mm) Ø 16 in (400 mm)
		Ø 12 in (315 mm) Ø 14 in (355 mm)	Ø 16 in (400 mm) Ø 14 in (355 mm)
	147 rpm	187 rpm	211 rpm
	161 rpm	204 rpm	230 rpm
	174 rpm	221 rpm	249 rpm
Stabilization application			
Crushing application			

\*) The rotor speed depends on the selected diesel engine speed



02 Belt drive for the crushing and mixing rotor.

# PRECISE ADDITION OF WATER

**01** The injection system feeds water into the mixing chamber in a micro-controller controlled process in accordance with the mix formula to achieve the optimum moisture content.

**02** Ideal overview: key machine parameters are also continuously displayed in the metering menu on the lower menu bar.

**03** Parameters such as the spray width and spray volume can be set intuitively.

## Microprocessor-Controlled Addition of Water

To achieve high-quality mixing results, it is insufficient to input the required parameters just once. They must also be kept constant as the work progresses. The WRC has all it takes to meet these requirements: Inputs are convenient and easy to make using just a few controls in the left armrest console and via the display.

Clearly and logically structured menus enable the operator to quickly access individual pages. Thanks to large, easily comprehensible displays, the operator is always kept fully informed of the current

parameters as the work progresses. If specific values (such as additive quantity or spraying width) require correction, these can be quickly and easily adjusted.

Microprocessors regulate the addition of water by means of flow meters. The specific additive feed rate depends on preselected parameters such as the working width and depth, the material density, and the machine advance rate. The injection bars are equipped with up to 16 nozzles, each of which can be activated or deactivated at any time to vary the spraying width.

01

## Pinpoint Precision

Microprocessor-controlled addition of binding agents

## Perfect Injection Pressure

VARIO Injection Bars

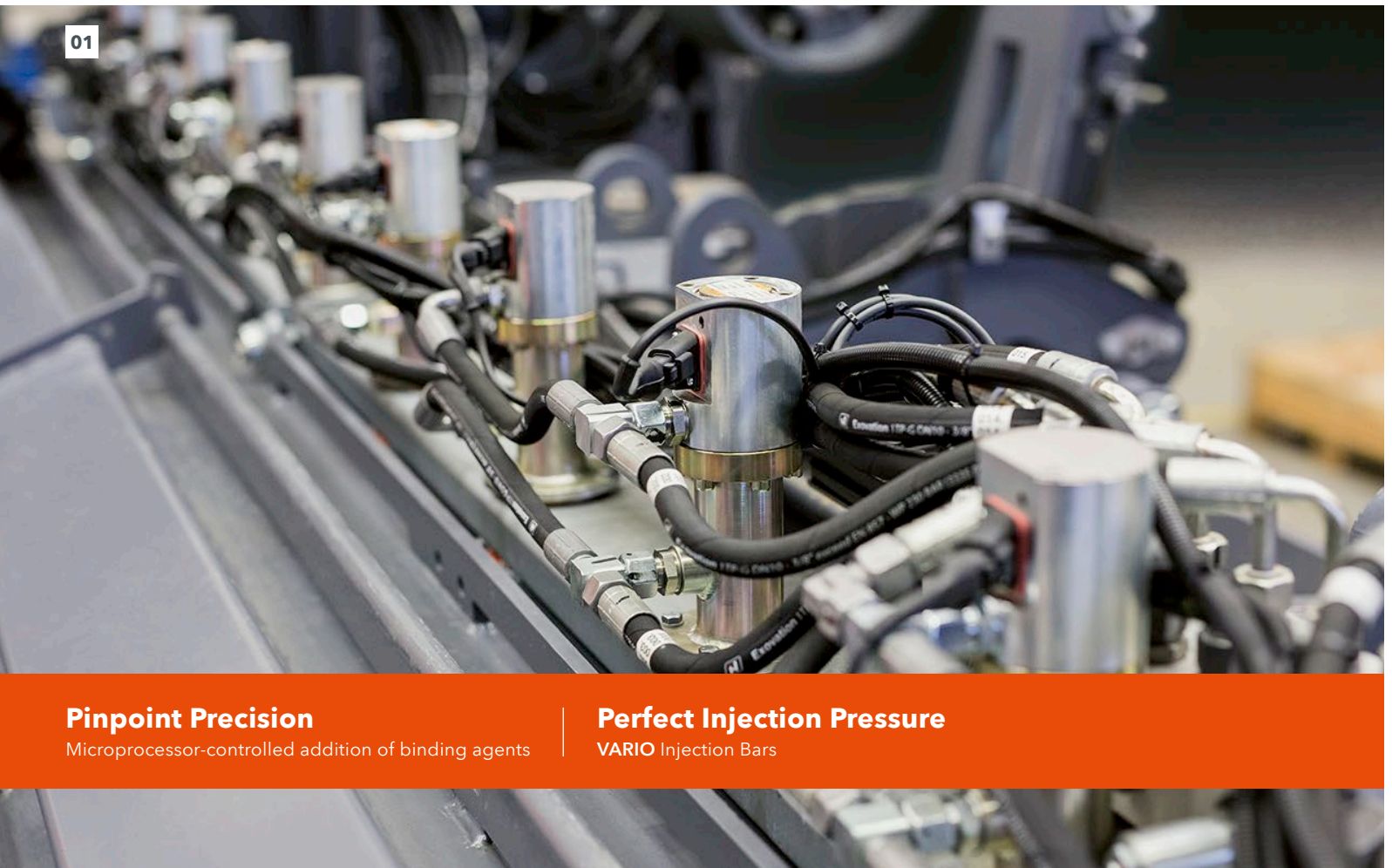

**Constant Injection Pressure**

The nozzles of **VARIO** injection bars are equipped with a variable nozzle cross-section. This enables constant injection pressure to be maintained, regardless of the volume. This ensures

an ideal and even distribution in the crushing and mixing unit across the defined spraying width, and thus assures the homogeneity of the mix. The spraying width can also be adjusted to meet specific requirements.



Low spraying volume

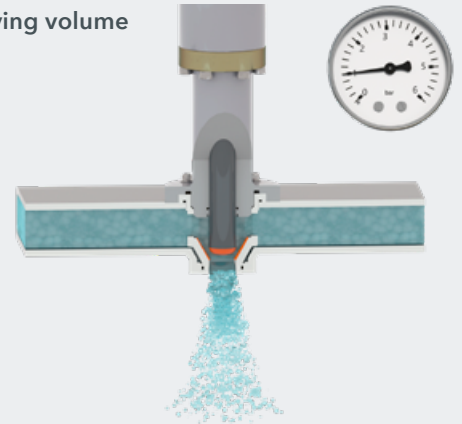

High spraying volume

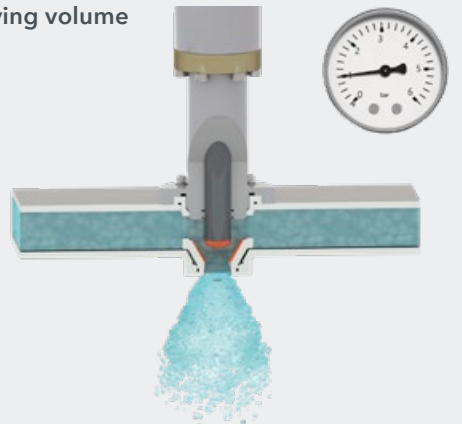

Cleaning - manual pricking

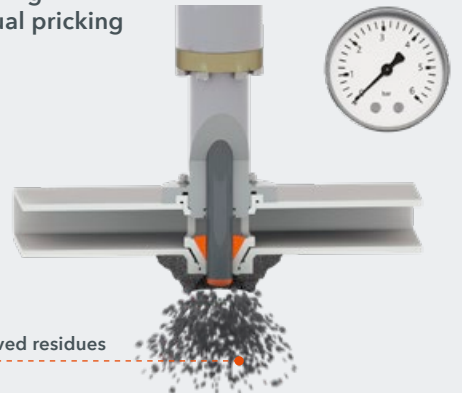

Functional principle: variable cross-section of a nozzle on the injection bar for water or bitumen emulsion.

# PRECISE ADDITION OF WATER

## Injecting Water

Exact compliance with the specified metering of additives is essential for assuring high-quality stabilization and recycling processes. The WRC is ideally equipped to meet these requirements: The solidly engineered, microprocessor-controlled injection system guarantees precise metering of the water to be added.

In addition, a special quick-mounting system enables quick installation and deinstallation of the injection bars.



01 The hose connection is mounted on the front crossbeam.

## Ideal Moisture Content

Precise Water Metering



01 Water supply hose

02 Injection bar for water

03 Sprayed-in water

The microprocessor-controlled injection bar sprays the required amount of water into the mixing chamber.



The innovative Rock Crusher with its high-performance crushing, screening, and mixing unit can crush, process, and homogenize hand-packed pavement layer (e.g. Telford base), concrete fragments, cobblestones, and rocks at production rates of up to 600 t/h. With a working width of 2.32 m and a maximum working depth of 510 mm, the Rock Crusher impresses with exceptional performance in all areas of soil stabilization as well as in the processing of a variety of materials. The robust crushing and mixing unit with HT18 tools developed especially for use in the crushing application and a variable mixing chamber enable the realization of highest efficiency and best mixing results.



TECHNICAL SPECIFICATIONS	WRC 240	WRC 240 i
<b>Crushing and Mixing Rotor</b>		
Working width	7 ft 7 in (2,320 mm)	
Working depth <sup>1)</sup>	0 to 20 in (0 to 510 mm)	
Tool spacing	1 in (25 mm)	
Number of tools	96	
Cutting diameter	4 ft 10 in (1,480 mm)	
<b>Engine</b>		
Engine manufacturer	Cummins	
Type	QSX 15	X-15
Number of cylinders	6	
Power	447 kW / 600 HP / 608 PS	
Maximum power at 2,100 min <sup>-1</sup>	455 kW / 610 HP / 619 PS	
Displacement at 1,900 min <sup>-1</sup>	4 gal (15 l)	3.9 gal (14.9 l)
Fuel consumption, full load   mixed site operations	31.7 gph   15.9 gph (120 l/h   60 l/h)	30.4 gph   14.5 gph (115 l/h   55 l/h)
Sound power level according to EN 500-3, engine   operator's platform	≤110 dB(A)   ≥76 dB(A)	≤109 dB(A)   ≥72 dB(A)
Exhaust emission standard	EU Stage 3a / US EPA Tier 3	EU Stage 5 / US EPA Tier 4f / CN NR Stage 4
<b>Electrical System</b>		
Power supply	24 V	
<b>Tank Capacities</b>		
Fuel	396 gal (1,500 l)	365 gal (1,380 l)
AdBlue® / DEF <sup>2)</sup>	—	26.4 gal (100 l)
Hydraulic oil	84.5 gal (320 l)	
Water	132 gal (500 l)	
<b>Driving Performance</b>		
Working speed in crushing and travel gear	0 to 689 ft/min (7.8 mph) (0 to 210 m/min (0 to 12.6 km/h))	
Max. cross slope	8°	
Ground clearance	approx. 16 in (400 mm)	
<b>Tires</b>		
Tire size, front / rear	28L - 26	
<b>Transport Dimensions</b>		
Dimensions for truck / trailer transport (L x W x H)	30 ft 3 in x 9 ft 10 in x 9 ft 10 in (9,230 x 3,000 x 3,000 mm)	

<sup>1)</sup> The maximum working depth may deviate from the value indicated due to tolerances and wear

<sup>2)</sup> AdBlue® is a registered trademark of the German Association of the Automotive Industry (VDA)



TECHNICAL SPECIFICATIONS	WRC 240	WRC 240i
<b>Weight of Basic Machine</b>		
Empty weight of machine with standard equipment without fluids	72,091 lbs (32,700 kg)	73,414 lbs (33,300 kg)
Operating weight, CE <sup>1)</sup>	74,296 lbs (33,700 kg)	75,619 lbs (34,300 kg)
Maximum operating weight (full tanks, full range of equipment)	78,705 lbs (35,700 kg)	80,028 lbs (36,300 kg)
<b>Weight of Tank Contents</b>		
Water	1,102 lbs (500kg)	
Fuel (0.83 lbs / kg)	2,745 lbs (1,245 kg)	2,524 lbs (1,145 kg)
AdBlue® / DEF <sup>2)</sup>	—	221 lbs (100 kg)
<b>Additional Weights</b>		
<b>Operator and tools</b>		
> Machine operator	165 lbs (75 kg)	
> 5 pick buckets	276 lbs (125 kg)	
<b>Alternative to standard injection system</b>		
> Single spraying system (FB2320) with VARIO spraying bars for water or bitumen emulsion (211 gal/min (800 l/min))	860 lbs (390 kg)	
<b>Screen segments</b>		
> 6 exchangeable screen segments with 1.8 in (45 mm) mesh size	320 lbs (145 kg)	
> 6 exchangeable screen segments with 2.6 in (65 mm) mesh size	309 lbs (140 kg)	

<sup>1)</sup> Machine weight, half weight of all tank contents, on-board tool kit, machine operator, no additional options

<sup>2)</sup> AdBlue® is a registered trademark of the German Association of the Automotive Industry (VDA)

SIDE VIEW / TOP VIEW WRC 240(i)

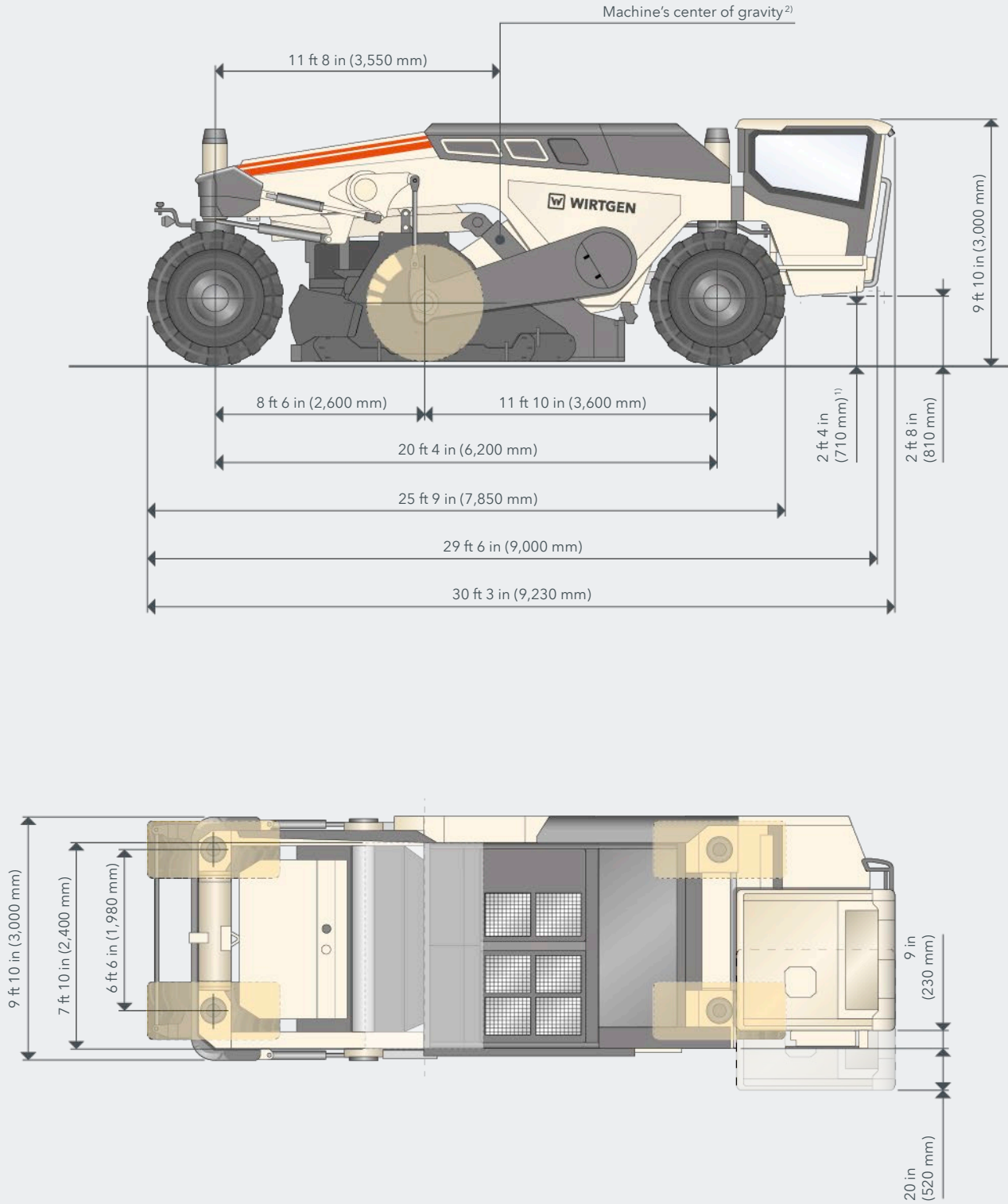

<sup>1)</sup> With injection system

<sup>2)</sup> Based on operating weight, CE

# TURNING RADIUS WRC 240(i)



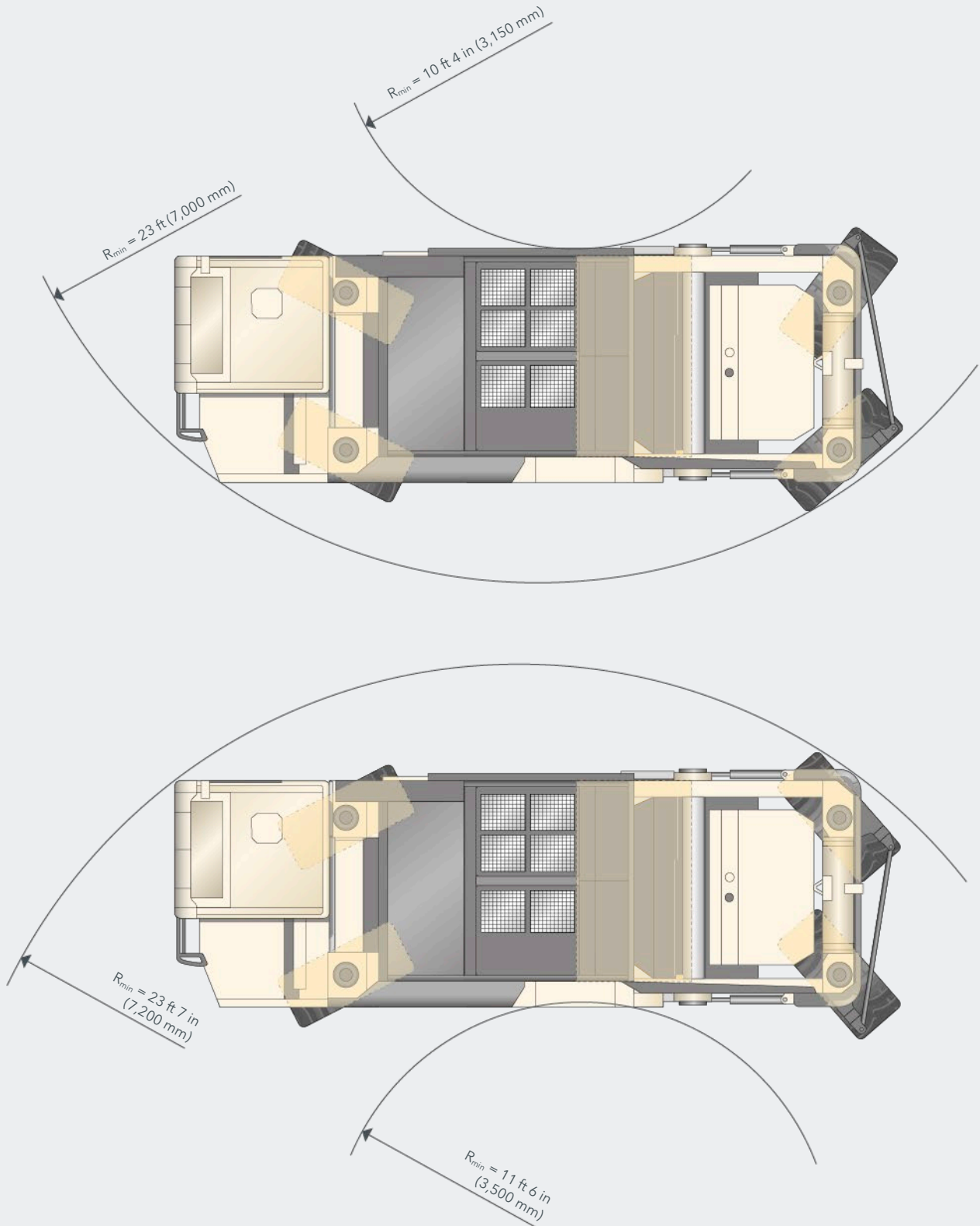

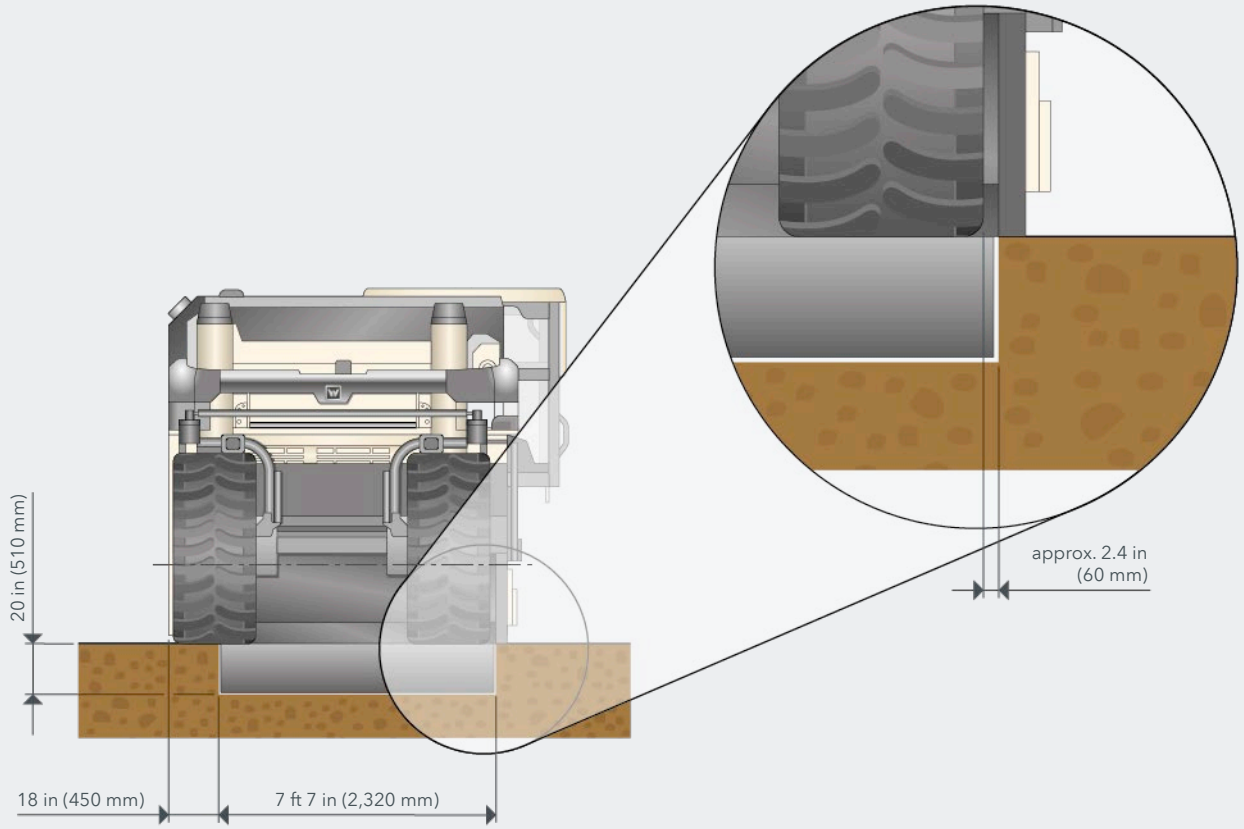

---



REAR VIEW WRC 240(i)



ROTOR SPEED WRC 240(i)\*)

WRC 240 (i)	Engine speed	 Ø 16 in (400 mm) / Ø 12 in (315 mm)	 Ø 12 in (315 mm) / Ø 16 in (400 mm)	 Ø 14 in (355 mm) / Ø 14 in (355 mm)
		147 rpm	187 rpm	211 rpm
	161 rpm	204 rpm	230 rpm	
	174 rpm	221 rpm	249 rpm	

\*) The rotor speed depends on the selected diesel engine speed

**STANDARD EQUIPMENT WRC 240 (i)****Basic Machine**

- |   |   |
|---|---|
| > Base machine with engine  | ■ |
| > Machine chassis with integrated water tank and free view of the right working edge  | ■ |
| > The right wheels are positioned within the working width for working flush with the edge  | ■ |
| > Diesel engine power controller for optimum crushing and mixing results  | ■ |
| > Engine cooling system with temperature-controlled fan speed   | ■ |
| > Air compressor system, max. 116 psi (8 bar)   | ■ |
| > Lockable engine cover with built-in sound insulation package  | ■ |
| > Mechanical rotor drive via a power belt with automatic belt tensioner   | ■ |
| > Variable rotor speed through combination of 3 selectable motor speeds and 3 changeable pulley arrangements to achieve optimum working results | ■ |
| > Hydraulically adjustable crusher bar in front of the rotor  | ■ |
| > Hydraulically adjustable scraper blade behind the rotor   | ■ |
| > Hydraulically adjustable intake flap in front of the rotor  | ■ |
| > Hydraulically adjustable intake flap in front of the rotor  | ■ |
| > Stepless working depth adjustment by lowering or raising the complete rotor   | ■ |
| > Automatic adjustment to the respective working depth (larger mixing chamber with greater working depth)                                       | ■ |
| > Power-controlled lowering speed of the milling drum in starter mode   | ■ |

**Crushing and Mixing Rotor**

- |  |   |
|--|---|
| > Crushing and mixing rotor FB2320 HT18 LA25 with 96 flat bits and 8 edge protectors | □ |
|--|---|

**Injection System / Addition of Binders**

- |   |   |
|---|---|
| > Model without spraying system                               | □ |
| > Connection coupling for a version without a spraying system | □ |

**Machine Control and Leveling System**

- |   |   |
|---|---|
| > Multifunctional color control display that shows important machine operating conditions                         | ■ |
| > Comprehensive machine diagnostics displayed on the control screen   | ■ |
| > Programmable automatic system for initiating and completing the milling process at the particular working depth | ■ |
| > Automated features to reduce the machine operator's workload  | ■ |

## STANDARD EQUIPMENT WRC 240 (i)

### Operator's Platform

> Comfortable, high-quality cabin with flexible mountings, with roof hatch and individually adjustable heating	■
> Ergonomic, air-cushioned operator's seat	■
> Roll-over protection system (ROPS and FOPS) integrated in the cab frame	■
> Large windows with an excellent view of the respective work area and built-in windshield wipers	■
> Recirculating and fresh air filters can be changed without tools	■
> Various shelves and storage compartments as well as 12 V and 24 V sockets	■
> In order to provide an ideal view over the zero edge, the operator's cabin can be shifted over the right-hand side of the machine	■
> Rotation of the operator's platform through 90° offers optimum adaptation to the particular working situation	■
> Individually adjustable control panel with color display	■
> Reversing camera with graphical reversing assistant	■
> Mirrors on right and left in the front area of the machine	■
> Working lights integrated into the cabin roof	■
> Folding ladder to access the operator's platform	■

### Track Unit and Height Adjustment

> Infinitely adjustable, hydraulic all-wheel drive	■
> Four-way tilting of the lifting columns to compensate for uneven terrain	■
> Electrohydraulic, light all-wheel steering, with the "crab", "cornering" or "straight ahead" steering types	■

### Miscellaneous

> "Welcome-and-Go-Home-Light" with LED lighting in the ladder area	■
> Extensive safety package with 3 EMERGENCY STOP switches	■
> Large tool kit in lockable tool box	■
> Pre-fitting for installing the WITOS FleetView control unit	■
> European type certification, EuroTest mark and CE conformity	■
> Torque multiplier incl. torque spanner for changing the HT18 tools	■
> Standard painting in RAL 9001 (cream)	□
> WITOS - professional telematics solution for optimising machine usage and servicing for <b>WPT</b> Recycling	□
> Pre-fitting for WIRTGEN GROUP Performance Tracker Recycling and AutoTrac™	□
> Halogen lighting package, 24 V, including rotating beacon	□
> Battery-powered high-torque power screwdriver for loosening and fastening crushing tools	□

- = Standard equipment  
 □ = Standard equipment, can be replaced with optional equipment if desired  
 □ = Optional equipment

**OPTIONAL EQUIPMENT WRC 240 (i)**

**Crushing and Mixing Unit**

- > 6 exchangeable screen segments with mesh size 3.3 in (85 mm)
- > 6 exchangeable screen segments with mesh size 1.8 in (45 mm)
- > 6 exchangeable screen segments with mesh size 2.6 in (65 mm)

**Injection System / Addition of Binders**

- > Single spraying system (FB2320) with VARIO spraying bars for water (211 gal/min (800 l/min))

**Machine Control and Leveling System**

- > Cross-slope sensor

**Operator's Platform**

- > Air conditioner
- > Radio system with two speakers and antenna



**OPTIONAL EQUIPMENT WRC 240 (i)**

**Miscellaneous**

> Painting in one special color (RAL)	<input type="checkbox"/>
> Painting in two special colors (RAL)	<input type="checkbox"/>
> Model without WITOS	<input type="checkbox"/>
> Version without pre-fitting for WIRTGEN GROUP Performance Tracker Recycling and AutoTrac™	<input type="checkbox"/>
> High-performance LED lighting package with patrol lights	<input type="checkbox"/>
> Printer for recording the job data	<input type="checkbox"/>
> USB interface for retrieving the job data	<input type="checkbox"/>
> WIRTGEN GROUP Performance Tracker Recycling - determining the precision mixing	<input type="checkbox"/>
> WIRTGEN GROUP Performance Tracker Recycling and AutoTrac™ - determining the precision mixing with satellite-based steering system	<input type="checkbox"/>
> Powerful high-pressure water cleaner, 2,176 psi (150 bar), 4 gal/min (15 l/min)	<input type="checkbox"/>
> Battery-operated hydraulic unit	<input type="checkbox"/>
> Rotor rotation device	<input type="checkbox"/>
> Diesel tank filling pump with 24 ft 7 in (7.50 m) suction hose	<input type="checkbox"/>
> Wiggins fast-fill system for diesel refueling	<input type="checkbox"/>
> Additional monitor system including 3 cameras and monitor	<input type="checkbox"/>
> License plate holder with LED lighting	<input type="checkbox"/>
> 3" water or emulsion suction hose, 5,000 LG - tanker connection	<input type="checkbox"/>
> Support arm for holding the push bar and feed lines whilst changing tankers	<input type="checkbox"/>

- = Standard equipment
- ▒ = Standard equipment, can be replaced with optional equipment if desired
- = Optional equipment

**WIRTGEN AMERICA Inc.**

6030 Dana Way  
Antioch, TN 37013  
USA

P: (615) 501-0600

F: (615) 501-0691

 [www.wirtgen-group.com/america](http://www.wirtgen-group.com/america)



Please scan the code for further information.