

Effective and Environmentally Friendly Mix Preparation

# KMA 240 (i) MOBILE COLD RECYCLING MIXING PLANT



# EFFECTIVE AND ENVIRONMENTALLY FRIENDLY MIX PREPARATION

The KMA 240(i) high-performance cold recycling mixing plant is designed for the resource-friendly production of high-quality mix at an enormous mixing capacity of more than 240 t/h.

The KMA 240(i) is capable of processing a wide variety of base materials, such as recycled construction materials, milled asphalt material, demolished concrete, or virgin road construction materials, as well as binding agents, such as cement, bitumen emulsion, or foamed bitumen.

The mix is ideally suited for any type of construction project, e.g. for cement-treated or long-lasting bituminous base layers in road and path construction, parking lots, and industrial areas.

The mobile design of the cold recycling mixing plant allows the machine to be transported directly to the job site, saving both time and money.

The ability to completely recycle materials in combination with cold processing results in significant CO<sub>2</sub> and energy savings with minimal construction costs and project periods.





**WIRTGEN RECYCLERS AND SOIL STABILIZERS**

**TRACTOR-TOWED STABILIZERS**

- > Working width up to 2,500 mm
- > Working depth up to 500 mm

**COLD RECYCLERS AND SOIL STABILIZERS (WHEELED CHASSIS)**

- > Working width up to 2,400 mm
- > Working depth up to 560 mm

**COLD RECYCLERS (CRAWLER UNIT CHASSIS)**

- > Working width up to 3,800 mm
- > Working depth up to 350 mm

**MOBILE COLD RECYCLING MIXING PLANT**

- > Mixing capacity up to 240 t/h

**LABORATORY EQUIPMENT**

# A WIDE RANGE OF APPLICATIONS: NUMEROUS DIFFERENT ROAD SURFACES

## Recipe for success for hard-wearing road surfaces

The KMA 240(i) cold recycling mixing plant produces cold mix that can be paved immediately for a wide variety of construction projects, such as cement-treated base (CTB) layers for freeways. Due to the particularly generous, continuous addition of cement, enormous daily outputs can be achieved with maximum precision.

In addition to CTB and RCC (roller-compacted concrete), cold mix can be produced that is stabilized with bitumen emulsion or foamed bitumen (BSM).

The road surfaces produced from these high-quality cold mixes then stand out due to their excellent bearing capacity, resistance to deformation, and long service life.

## Eco-friendly technology

The highly mobile cold recycling mixing plant can be easily transported from site to site and quickly set up in the near vicinity. This saves time, truck capacity, and is also extremely environmentally friendly, making it possible to achieve up to 60% fewer CO<sub>2</sub> emissions thanks to cold processing, a 90% reduction in transport volumes, and up to 50% lower total costs compared to conventional construction methods - in other.

01



## Sustainable Cold Recycling Technology

- Reduces material disposal costs by **up to 100%**
- Reduces material transports by **up to 90%**
- Reduces resource consumption by **up to 90%**
- Reduces CO<sub>2</sub> emissions by **up to 60%**
- Reduces construction time by **up to 50%**
- Reduces total costs by **up to 50%**



02

- 01 Cold recycling conserves resources and offers enormous savings potential.
- 02 The cold mix produced by the plant is internationally approved for the construction of freeways and high-quality base layers in road and path construction.
- 03 The production of cement-treated base (CTB) layers is one of the field-proven standard construction methods.



03



# A WIDE RANGE OF APPLICATIONS: NUMEROUS DIFFERENT MATERIALS

## A Wide Range of Applications

A particularly impressive feature of the KMA 240(i) is its ability to process a variety of different, non-cohesive raw materials. As a result, mixes can be produced from a wide variety of virgin construction materials, reclaimed recycled materials, and binding agents.

Virgin construction materials include raw materials such as mixtures of sand, gravel, or crushed stone. Recycled construction materials include milled material and all other materials reclaimed from old road surfaces or processed rubble, e.g. RCL (recycled gravel) or asphalt milled material.

Cement, bitumen emulsion, or foamed bitumen supplied by silo or tanker trucks are the most suitable binding agents. The required quantity of binding agents and aggregates is precisely determined by preliminary tests in the road construction laboratory. Based on these specifications, the plant then prepares the homogeneous mix with the desired properties.

Foamed bitumen for the construction of durable BSM base layers is an extremely cost-effective binding agent, as the quantities added are extremely low.

01



02



**01** Innovative ideas can be used to implement a variety of cost-effective solutions.

**02** A wide range of different construction materials and binding agents is available.



**Road structure with BSM (example)**



**Road structure with CTB (example)**

Test specimens can be easily produced, e.g. for BSM or CTB road structures.

# OVERVIEW OF HIGHLIGHTS

## Perfectly Equipped

### 01 One-of-a-kind mobility and flexibility

- > Compact transport dimensions of the entire plant for easy transport without requiring a special permit
- > Rapid setup and disassembly of the plant thanks to hydraulic components and quick-release connectors
- > Compact footprint and flexible additive connection options allow the plant to be operated in a very confined space
- > Stand-alone job site operation due to separate power unit

### 02 Simple, intuitive operation

- > Clearly arranged control panel with material flow diagram for intuitive one-person operation
- > Color display provides a clear overview of all relevant process parameters at a glance
- > Display of extensive job data and professional job site logging
- > Ergonomic, air-conditioned comfort cabin
- > Excellent 360-degree visibility and camera system for a perfect overview of all important work processes
- > Ample construction site lighting with LED lighting balloon and LED light pole for 24-hour operation





## QUALITY

**03 Maximum productivity**

- > Over 240 t/h mix production possible for high daily output rates
- > Powerful, economical diesel engine
- > High-performance binding agent units for high feed volumes
- > High-capacity belt conveyor that can swing in both directions for continuous material loading
- > Fast maintenance and cleaning

**04 Effective mixing process**

- > Rugged, wear-resistant twin-shaft continuous mixer for homogeneous mixes
- > Continuous or batchwise weighing of mixing jobs that need to be completed
- > The filling level can be variably adjusted to the required mixing capacity during mixing operation

## PERFORMANCE

**05 Optimal material flow with intelligent functions**

- > Perfectly compatible system consisting of the material hopper, dosing units, and mixer
- > Active limit load controller throughout the entire mixing and dosing process for optimized plant performance
- > Central lubrication system for the mixer bearing, mixer shaft seal, and discharge conveyor
- > Belt conveyor system with effective scraper brushes for reliable cleaning
- > Generously sized material hopper for two different fractions
- > Material feeding via hinged vibrating grates for reliable screening of oversized particles
- > Regular, automatic vibration function for the material hopper and vibrating grates
- > Discharge conveyor features precise weighing technology using a dosing slider and belt conveyor scales
- > Material flow from the hopper monitored by laser scanner

**06 Precise binding agent addition**

- > Gravimetric cement dosing via innovative double trough system for exact, continuous binding agent addition
- > Quantity of binding agent added is continuously monitored for maximum process reliability
- > Automatic self-calibration of the dosing units immediately after beginning work
- > An injection system for foamed bitumen or emulsion with adjustable heating temperature
- > Precise water injection system with large water tank



# ONE-OF-A-KIND MOBILITY AND FLEXIBILITY

## Compact transport dimensions

The well-engineered design allows the compact system to be easily and safely “packed up” onto a flatbed truck trailer and transported to the next site, saving both time and money. All you need to do is swivel in the discharge conveyor and operator’s cabin, move the cement charging auger to the transport position, and then hitch up the plant. A common truck is completely sufficient for transporting the plant as all of its connectors are standardized.

The compact transport dimensions and low overall weight of the KMA 240(i) comply with international traffic regulations, eliminating the time-consuming process of applying for special permits in most locations.

## Rapid setup and disassembly

Setup and disassembly can be carried out quickly and easily without special tools – stable supports are extended and manually unfolded to ensure the plant stands securely. In addition, hydraulically powered, continuously extendable supports are mounted under the water tank and between the axles to support the machine’s weight. The hydraulic supports can be used to precisely level the plant.

Fold-out, stable flaps used to set up the loading ramp protect the free space under the plant. The only thing left to do is swing out the operator’s cabin and discharge conveyor at the push of a button and connect the cement charging auger via quick-release connectors – done!

01



**Fast Relocation Without the Red Tape**

Compact transport dimensions

**Arrive. Set up. Get started.**

Rapid setup and breakdown



- 01** The machine can be transported via a standard truck without a special permit.
- 02** Extend the hydraulically operated supports.
- 03** Fold out the front supports manually.
- 04** Bring the operator's cabin into position at the push of a button.
- 05** Extend the discharge conveyor hydraulically.
- 06** The plant is ready for operation after a short set-up time.

# ONE-OF-A-KIND MOBILITY AND FLEXIBILITY

## Flexibility in its Purest Form

Space-saving setup, multiple connections

## Continuous Autonomous Operation

Integrated diesel engine

01





**Small footprint and flexible connection options**

Flexibility was a top priority when designing the mobile mixing plant. This is why connections for water, emulsion, and bitumen are found in a number of locations. The same applies to the cement - whether via a stationary silo on the left or right or fed by hand, anything is possible. This gives you plenty of freedom when determining where to place the KMA 240(i). After all, the plant's direct proximity to the job site or materials warehouse offers an unbeatable advantage in terms of time, cost, and energy savings.

**Stand-alone job site operation**

The plant's own diesel engine not only ensures that it isn't dependent on the public power grid and guarantees an exceptionally high daily output, but can also be operated extremely efficiently for up to two days on a single tank of fuel.

**01** The mobile mixing plant is set up at the most logistically convenient location - including flexible, space-saving alignment. Here, storable mix is produced and stock-piled, then loaded onto trucks by a wheel loader.

# SIMPLE, INTUITIVE OPERATION

## Clearly arranged control panel with material flow diagram

The intuitive main control panel with easy-to-understand material flow diagram provides comprehensive information on the machine's status and the entire production process. The operator only has to set the feed volumes and the batch size and the plant takes care of the rest virtually automatically.

## Color display provides a clear overview

Work parameters are conveniently entered using only a few controls via the control panel. Clearly structured, self-explanatory menus allow the operator to quickly access individual pages. Thanks to large, easy-to-read color displays, the operator is always fully aware of the current parameters during the work process and can easily adjust the respective values, if necessary.

## Job data and job site logging

The control system automatically displays respective consumption values and batch information. Using the extensive job data - such as the precise batch history - it is easy to log daily outputs. The on-board printer makes it easy to log job data from individual batches or even complete construction projects in the form of a DIN A4 delivery document. Job data can also be stored on a USB flash drive.



01

01 The mobile remote control for the wheel loader driver, for example.

02 Clearly arranged control panel with material flow diagram as well as camera monitor and control screen

02



**Make the Right Decision**  
Intuitive operating

**Important Information at a Glance**  
Clearly laid-out flow diagram

# SIMPLE, INTUITIVE OPERATION

## Ergonomic, air-conditioned comfort cabin

It's a pleasure to operate the plant from the weatherproof operator's cabin. Ergonomically designed and arranged controls, a powerful air conditioning and heating system, excellent visibility and lighting, as well as plenty of space to move around and storage significantly enhance operator comfort and performance.

## Excellent 360-degree visibility and camera system

Excellent visibility is critical to productive work and efficient processes. Generously sized windows on the left, front, and right sides of the operator's cabin offer an unobstructed view of the entire job site. Windshield wipers provide a clear view in all weather conditions. In addition, the plant is equipped with a

rugged camera system with two cameras that provide a perfect view of the material hopper as well as of the material being loaded from the discharge conveyor into the truck. The two high-resolution camera images can be conveniently displayed on the camera monitor above the control panel.

## Ample construction site lighting

Intelligently arranged, high-intensity LED headlights plus an LED light pole and LED lighting balloon provide perfect visibility for maximum productivity, even in difficult lighting conditions. In addition, "welcome and go home" lighting illuminates the area around the machine with LED light when entering or leaving the operator's cabin.

01



**Relaxed Work**  
Comfort cabin

**Important Working Areas Permanently in View**  
Effective camera system



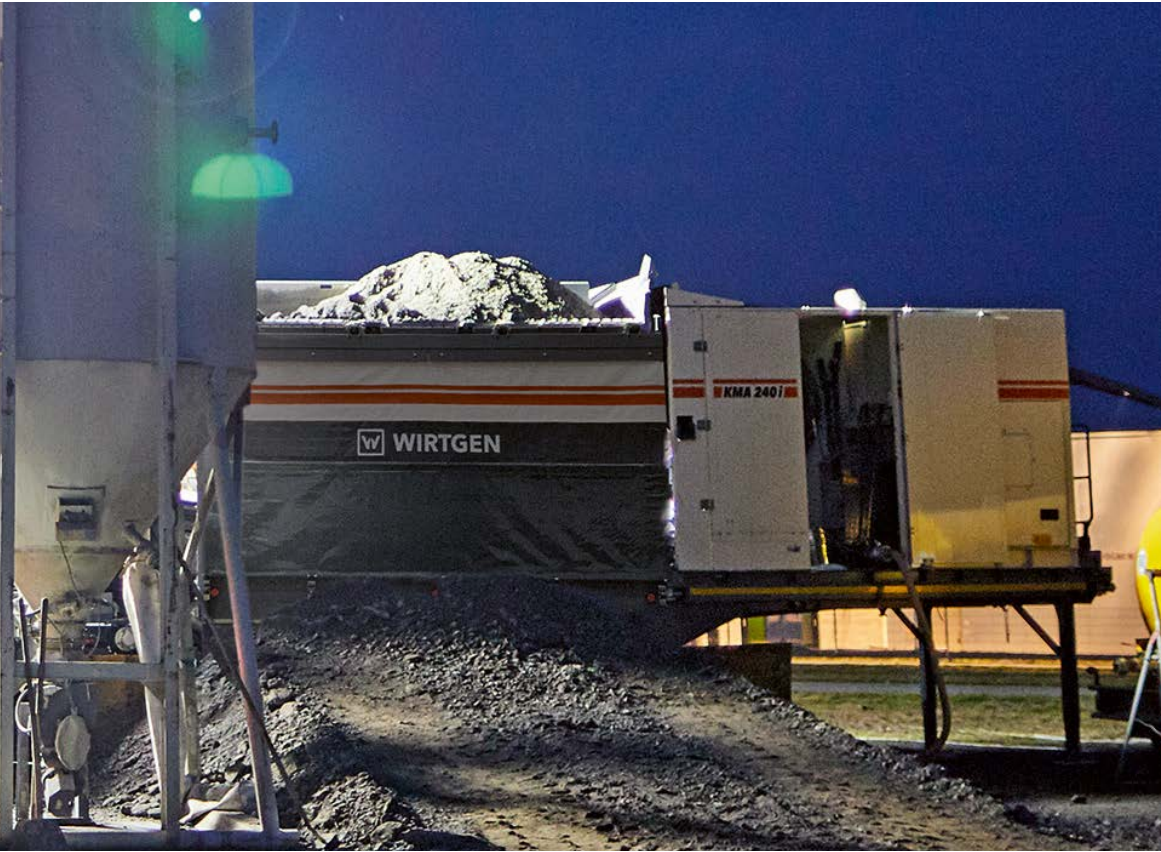

- 01** The high-performance lighting package guarantees maximum productivity, even in 24/7 operation.
- 02** The operator can easily see and control the entire plant from the air-conditioned cabin.



# MAXIMUM PRODUCTIVITY

## Mix production at a rate of over 240 t/h

At first glance, the KMA 240(i) appears comparatively small. But when it comes to performance, the exact opposite is true – the compact machine packs a punch. Powered by a heavy-duty diesel engine, it can produce high-quality mix at an astonishing rate of 240 t/h. This mixing capacity even far exceeds that of many stationary large-scale plants.

But it doesn't just come down to performance, a continuous supply of materials to the job site is also crucial.

This is guaranteed by the field-proven loading system of the KMA 240(i). The discharge conveyor features wide swing angles that make it possible to evenly fill semitrailer trucks.

With a capacity of 240 t/h, the machine produces a full truck-load of 20 tons of mix every five minutes. This means that, for example, an enormous section of a cement-treated or bituminous bound base layer 4.0 m wide, 15 cm thick, and 1.4 km long can be paved every day.

01



**01** At a mixing capacity of 240 t/h, for example, the brisk pace of the trucks will make short work of any job site.

**02** The high-performance mixing plant keeps construction costs and project periods to a minimum

## Higher mixing capacity than many stationary large-scale plants

Output of over 240 t/h



# MAXIMUM PRODUCTIVITY

01



## Powerful, economical diesel engine

The powerful six-cylinder diesel engine is designed for the machine's massive mixing capacity of up to 240 t/h. In addition, the environmentally friendly engine is enclosed in a soundproof housing and can be operated extremely efficiently for up to two days on a single tank of fuel. Low emission values mean the plant can also easily be used in urban areas.

## High-performance binding agent units for high feed volumes

The high-performance, generously sized binding agent units rapidly supply the required quantities of binding agents for high daily production rates of, for example, cement-treated base layers or RCC (roller-compacted concrete).

## High-capacity belt conveyor that can swing in both directions

To ensure the cold mix is discharged smoothly, the mobile KMA 240(i) is equipped with a powerful discharge conveyor with swing angles of 55° in both directions. This ensures the mix produced by the plant can be smoothly discharged onto stockpiles or rapidly and evenly filled into semitrailer trucks. When transporting the plant, the discharge conveyor can be folded in hydraulically.

## Effortless maintenance and cleaning

The plant's ample storage space and few service points are easily accessible from the ground. The central lubrication system also simplifies maintenance activities. One high-pressure connection point each at the front and rear of the plant enables all plant components to be thoroughly cleaned after the end of the shift.

## Flexible Loading

High-performance slewable discharge conveyor

## High Feed Volumes

Powerful Binding Units

02



01 - 02 New, homogeneous mix is flexibly loaded onto trucks or deposited on stockpiles via the discharge conveyor that can swing in both directions.

03



03 The plant stands out for its easy access to maintenance points and ample storage space.

# EFFECTIVE MIXING PROCESS

## Rugged twin-shaft continuous mixer

In order to maintain the tremendous output achieved by the KMA 240(i), the twin-shaft continuous mixer is designed to be particularly stable and wear-resistant. The mixer offers a homogeneous mixing capacity of over 240 t/h. The mixing paddles and the interior of the pugmill are made of highly wear-resistant material. The mixing paddles can be adjusted separately and can be individually replaced - just like the entire interior lining of the mixer, which is also replaceable. In addition, the current mixer pressure can be easily monitored via the color control screen in the operator's cabin.

## Continuous or batchwise weighing

Thanks to its proven microprocessor control system, the KMA 240(i) can produce and weigh mixes both in batches to be loaded onto trucks (ton preselection) and continuously, e.g. to deposit the mix onto stockpiles. When weighing in batches, the operator has the ability to select different batch sizes individually adapted to the truck's respective loading capacity.

01

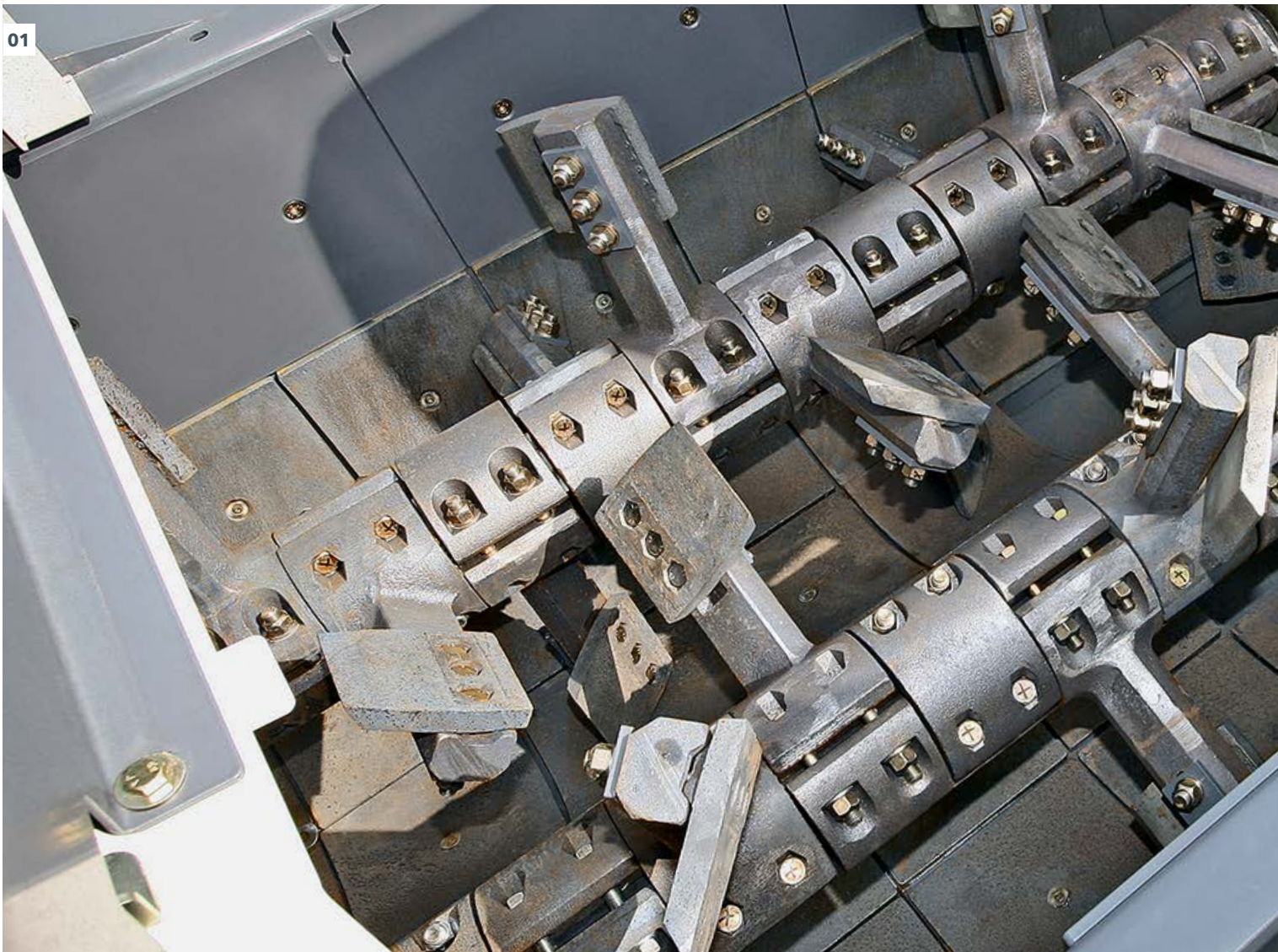



### Adjustable fill level in mixing operation

In order to achieve a consistently high mixing quality even when, for example, only low productivity is required or difficult to mix building materials are being used, the outlet cross section of the mixer can be manually adjusted, thereby optimally increasing the fill level in the mixer and the mixing time.

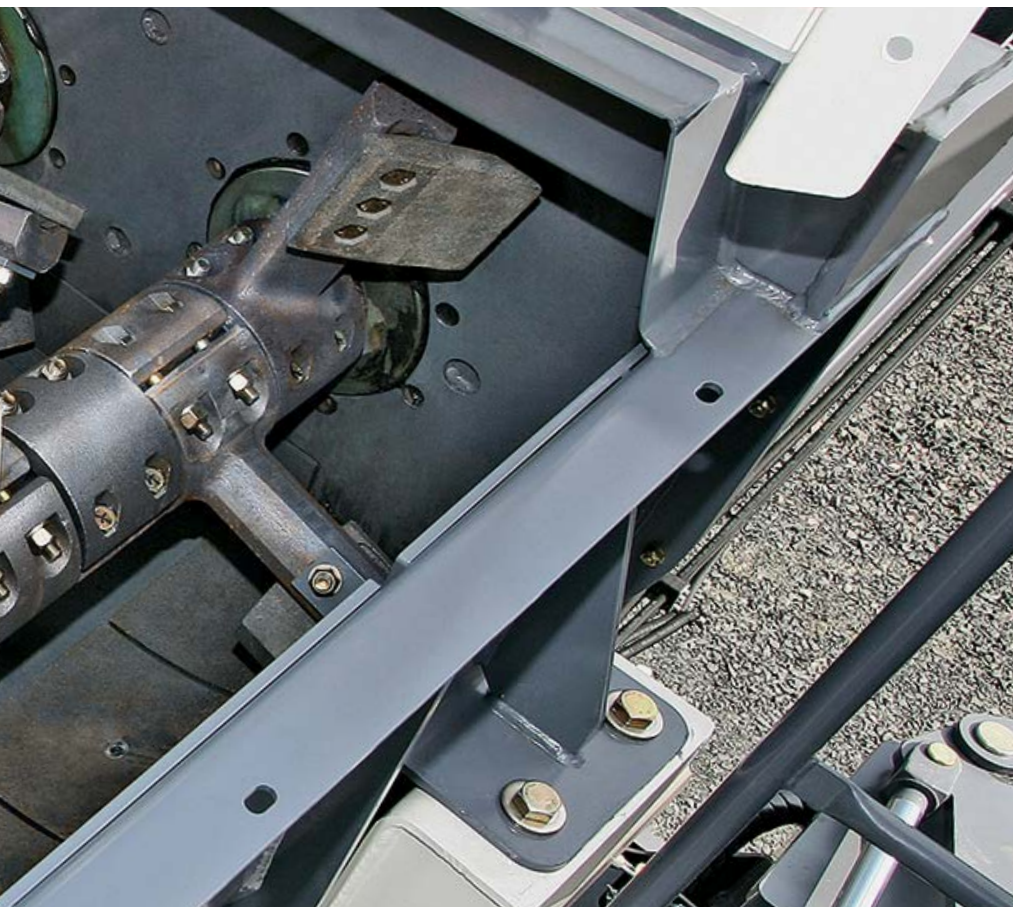

**01** Rugged mixing paddles made of wear-resistant tungsten carbide thoroughly mix all of the materials.

**02** Comprehensive displays clearly show the current mixing capacity or pressure values.

## Mixing That's Second to None

Robustly Constructed High-Performance Mixer

# OPTIMAL MATERIAL FLOW WITH INTELLIGENT FUNCTIONS

## Perfectly coordinated system

The main components of the plant - the material hopper, dosing units, and twin-shaft continuous mixer - mesh together perfectly, ensuring that the binding agents are added to the raw material weighed in the mixer precisely and simultaneously. The end result is a mix quality that precisely matches the required recipe.

## Limit load controller active throughout the entire mixing and dosing process

The dynamic, electronic limit load controller ensures that the plant reliably maintains maximum productivity while at the same time ensuring the highest possible quality of the paving mix. In this context, the limit load controller monitors all of the important parameters (e.g. binding agent, mixer utilization)

01





## Runs Like Clockwork

Perfectly matched components

and automatically regulates productivity in the event of material bottlenecks in order to continuously ensure that the mix is perfect.

### Central lubrication system

The central lubrication system for the mixer bearings, mixer shaft seal, and discharge conveyor automatically supplies important parts of the plant with the right amount of lubricant at the right time. The advantages of the central lubrication system

## The Perfect Mix

Electronic Load Limitation Regulator

include minimized down time, reduced wear, and a longer service life of the mixing plant.

### Belt conveyor system with effective scraper brushes

Effective and reliable belt cleaning by revolving scraper brushes on the underside of the belt not only prevents material build-up on the belt conveyor, but also keeps desired fines in the mix.

**01** Perfectly compatible system modules for optimum mix quality and high output.

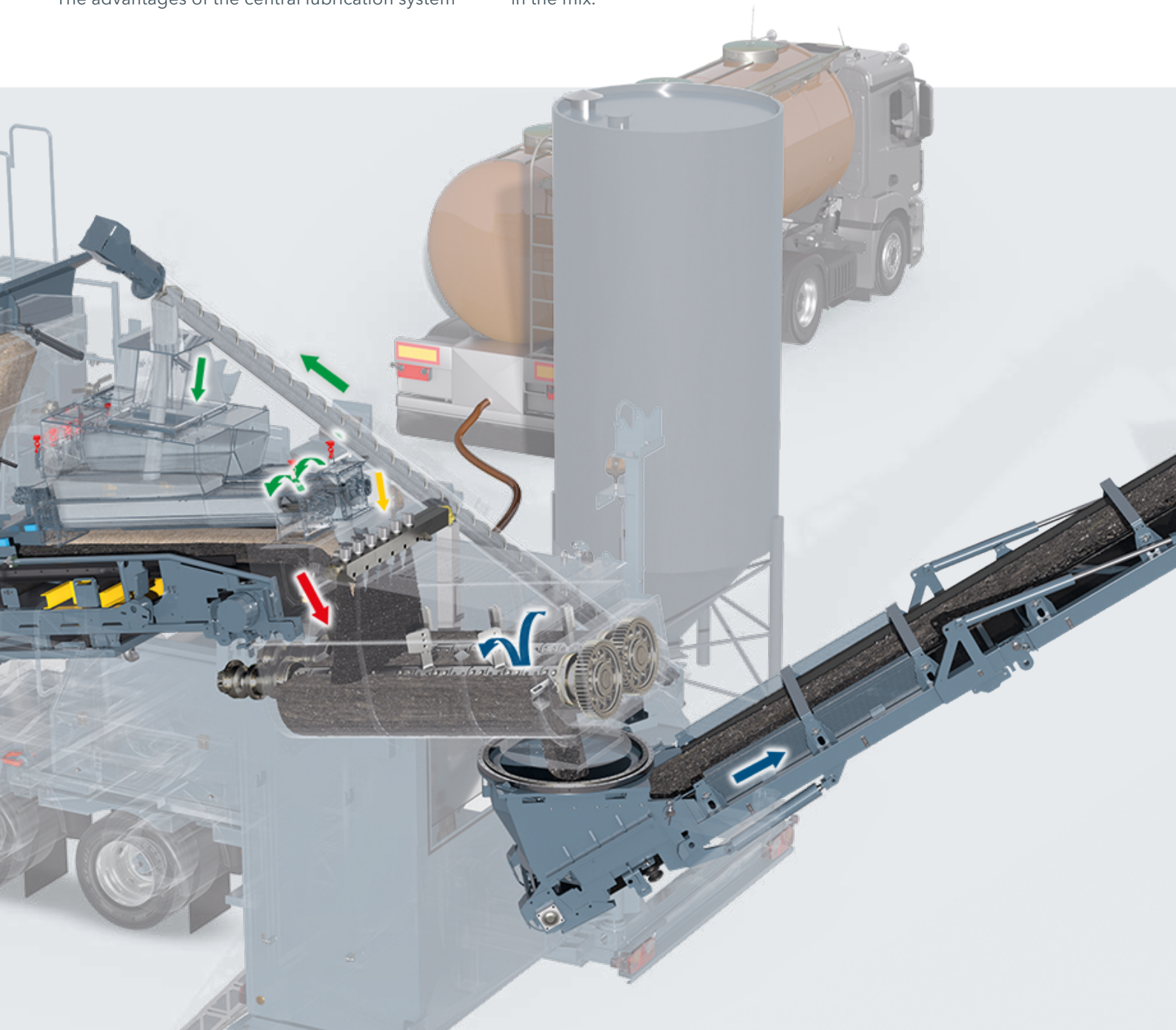

# OPTIMAL MATERIAL FLOW WITH INTELLIGENT FUNCTIONS

## Generously sized material hopper

The extra-large, vertically divided material hopper for double-sided feeding of two different fractions has a capacity of  $2 \times 6 \text{ m}^3$ . When producing mix with only one base material, the entire hopper volume of  $12 \text{ m}^3$  can be used.

## Material feeding via hinged vibrating grates

Grain sizes and foreign objects over 45 mm are reliably screened out by vibrating grates on the material hopper. To simplify cleaning, the hydraulically operated grates can be continuously and independently opened up to an angle of  $90^\circ$  at the push of a button.

## Regular, automatic vibration function

The material hopper and vibrating grates regularly and automatically vibrate to ensure that the material flows continuously, which also makes the operator's job easier.

## Discharge conveyor with precise weighing technology

The belt conveyor scales on the discharge conveyor determine the exact quantity currently being conveyed and feed the material to the mixer.



## For Enormous Quantities of Material

12 m<sup>3</sup> hopper capacity

## Display of proportional fractions

State-of-the-art laser scanner

### Material flow from the hopper monitored by laser scanner

For maximum productivity and the highest mix quality, the material flow from the two halves of the hopper is monitored by laser scanner and clearly indicated on the operating display. Maintaining the predefined ratio is extremely important when using two different aggregates - in this case, the percentages of both fractions can be easily viewed on the display.



- 01** Ability to add two different base materials.
- 02** Laser scanners monitor the respective ratio of two different fractions.
- 03** Two adjustable dosing sliders on the material hopper.
- 04** Hinged vibrating grates on the hopper can be positioned vertically and vibrated to facilitate cleaning.



# PRECISE BINDING AGENT ADDITION

## Gravimetric cement dosing via innovative double trough system

The innovative double trough system features two independent, state-of-the-art weighing units. This allows cement to be dosed gravimetrically from one trough while the other trough is simultaneously being filled with more cement and precisely weighed. The alternating dosing process is carried out with the utmost precision and without interrupting the addition of binding agent. The double trough system allows cement

to be added at a rate of up to 26 m<sup>3</sup>/h or, for example, 16.0% at a mix production rate of 160 t/h - but operates extremely precisely even at higher levels.

## Continuous monitoring of the quantity of binding agent added

Whether cement via weighing units or emulsion and foamed bitumen via flow-through meters - the control system of the KMA 240(i) is always precisely informed of the binding agent

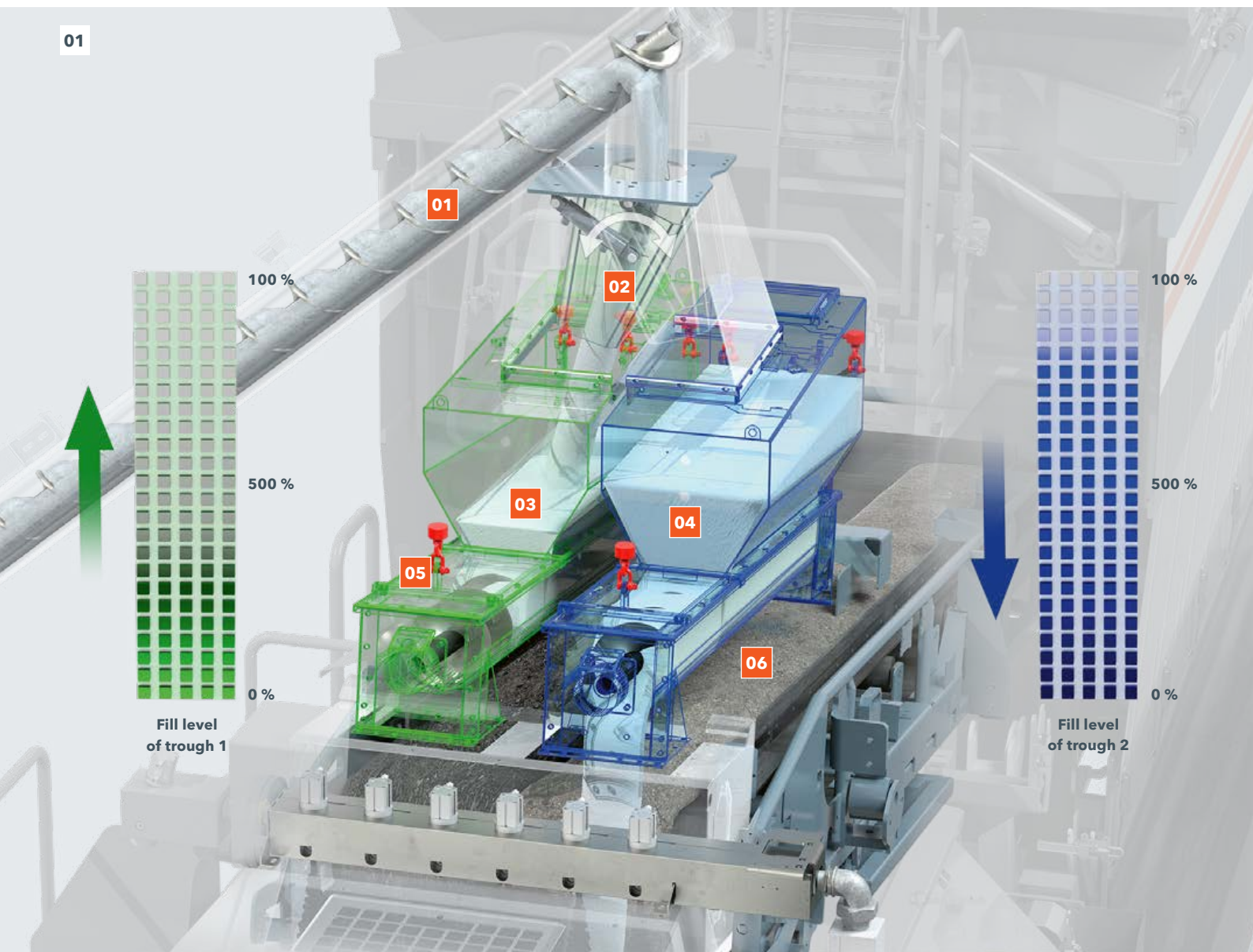

quantities currently being added, and regulates the quantities in the blink of an eye on the basis of the specified values. This means that the mixing capacity can be increased or reduced without any issue, even during an ongoing batch order.

#### Automatic self-calibration of the dosing units

Thanks to the double trough system's independently operating weighing units, dosing is carried out

from one trough while the other trough is simultaneously filled and weighed. The plant's control system continuously adjusts the fill weight in the trough (actual value) as well as the dosing quantity (target value). In this context, the system regulates the dosing rate continuously and fully automatically. Additional sensors monitor the maximum filling level of the binding agents. Exact dosing begins right from the very first kilogram.

**01** Double trough system for precise weighing and dosing of hydraulic binding agents.

**02** Automatic monitoring and control of the predefined feed quantities via the control display.

- 01** Cement charging auger
- 02** Hinged filler ports
- 03** Cement trough 1
- 04** Cement trough 2
- 05** Hanging scale with weighing unit
- 06** Material conveyed via discharge conveyor



**Ultra-Precise Dosing**  
Gravimetric Cement Addition

**Constantly Monitored Mixing Performance**  
Automatically Controlled Feed Quantities

# PRECISE BINDING AGENT ADDITION

## One injection system for foamed bitumen or emulsion

The built-in, microprocessor-controlled injection system can be used for the addition of both foamed bitumen and emulsion. In order to pave base layers of extremely high quality, the plant produces foamed bitumen in separate expansion chambers by injecting small quantities of water and compressed air into bitumen at a temperature of approx. 180 °C. The hot bitumen then foams abruptly, expanding to many times its original volume. In this state, the foamed bitumen spreads particularly evenly throughout the aggregate mix. The injection system is heated - the heating temperature can be set as required - eliminating the need to flush the system.

As a result, the system can also be easily switched from, for example, 180 °C heating temperature for foamed bitumen to 40 °C for the addition of emulsion. Furthermore, the easily accessible test nozzle makes it easy to check the quality of the foam.

## Precise water injection system

The heavy-duty eccentric auger pump with attached flow-through meter precisely adds the required amount of water to the mixing process. The current actual value is constantly compared with the preset target value and reacts precisely to the current mixing quantity. When the water tank trucks are changed, the 4,500 liter, permanently installed water tank ensures that the plant always has a sufficient supply of water.



**01** The microprocessor-controlled injection system precisely doses foamed bitumen or emulsion into the mixer. Flow switches monitor the flow of process water in order to produce foamed bitumen of outstanding quality.

**02** Mixes containing foamed bitumen are ideally suited for stockpile production due to their long storage life.

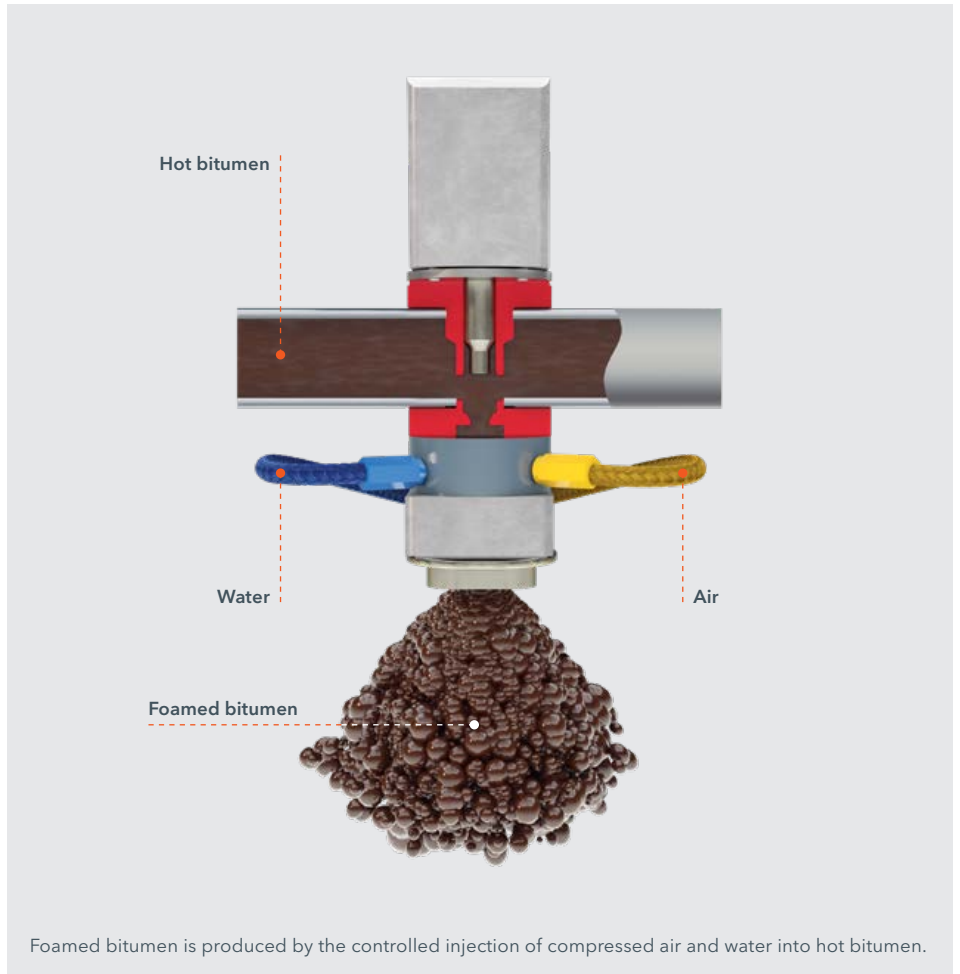

**2 in 1**

One Injection System for Foamed Bitumen or Emulsion

**Pinpoint Accuracy**

Precise addition of water

The KMA 240(i) high-performance cold recycling mixing plant is designed for the resource-friendly production of high-quality mix at a enormous mixing capacity of more than 240 tons per hour. The mobile design of the cold recycling mixing plant allows the machine to be transported directly to the job site, saving both time and money. The ability to completely recycle materials in combination with cold processing results in significant CO<sub>2</sub> and energy savings with minimal construction costs and project periods.



TECHNICAL SPECIFICATIONS	KMA 240	KMA 240 i
<b>Plant Performance</b>		
Mixing capacity	max. 240 t/h	
Max. particle size	45 mm	
<b>Aggregate Dosing</b>		
Hopper content	2 x 6 m <sup>3</sup>	
Feed width	3,710 mm	
Feed height (average)	3,600 mm	
<b>Mixer</b>		
Design	Twin-shaft pugmill	
Operating principle	Continuous mixer	
Engine power	2 x 30 kW	
Wear protection	Wear lining on all sides	
<b>Engine</b>		
Manufacturer	Deutz	Deutz
Type	TCD 2012 L06 2V	TCD 6.1 L6
Number of cylinders	6	6
Rated power at 2,100 rpm	129.4 kW / 174 HP / 176 PS	129 kW / 173 HP / 175 PS
Displacement	6,060 cm <sup>3</sup>	6,060 cm <sup>3</sup>
Fuel consumption, full load	36 l/h	33 l/h
Sound power level in accordance with EN 500-3, engine   operator's platform	≤ 103 dB(A)   ≥ 67 dB(A)	≤ 103 dB(A)   ≥ 67 dB(A)
Emissions standard	EU Stage 3a / US EPA Tier 3	EU Stage 5 / US EPA Tier 4f
<b>Electrical System</b>		
Power supply	24 V	
<b>Tank Capacities</b>		
Fuel	400 l	
AdBlue® / DEF <sup>1)</sup>	–	45 l
Hydraulic oil	200 l	
Wasser	4,500 l	



TECHNICAL SPECIFICATIONS	KMA 240	KMA 240 i
<b>Conveyor Capacity</b>		
Feeding auger for hydraulic binding agents		26 m <sup>3</sup> /h
Added water		200 l/min
Added emulsion		180 l/min
Added hot bitumen for foamed bitumen		160 l/min
Heating for hot bitumen system		42 V
<b>Conveyor</b>		
Belt width of conveyor to mixer		1,000 mm
Belt width of discharge conveyor		800 mm
Discharge conveyor swing angle (right / left)		20° / 35°
<b>Transport Dimensions</b>		
Length with operator's cabin		15,020 mm
Width		2,500 mm
Height		4,000 mm
Dimensions of operator's cabin (L x B x H)		2,500 x 1,650 x 3,000 mm

<sup>1)</sup> AdBlue® is a registered trademark of the German Association of the Automotive Industry (VDA).

TECHNICAL SPECIFICATIONS	KMA 240	KMA 240 i
<b>Weight Specifications</b>		
Empty weight of machine with standard equipment without fluids	29,200 kg	29,350 kg
Operating weight, CE <sup>1)</sup>	31,650 kg	31,850 kg
Maximum operating weight (heaviest configuration with full tanks)	35,500 kg	35,700 kg
<b>Weight of Tank Contents</b>		
Water	4,500 kg	4,500 kg
Fuel (0.83 kg/l)	330 kg	330 kg
AdBlue® / DEF <sup>2)</sup> (1.1 kg/l)	–	50 kg
<b>Increase / Decrease in Weight Compared to Net Weight as a Result of Optional Equipment</b>		
<b>Injection System Instead of Standard</b>		
> <b>ESL bitumen emulsion:</b> Injection system for bitumen emulsion		215 kg
> <b>ESL foamed bitumen:</b> Injection system for foamed emulsion		750 kg
<b>Additional Equipment</b>		
> Air conditioner		135 kg
> Feed hopper for manually adding cement		50 kg
> Active cleaning brush on the discharge conveyor		85 kg
> Material baffle plate at the discharge conveyor		80 kg
> Central lubrication system		75 kg
> Heated bitumen hose 3" x 6 m		60 kg
<b>Transport Weights</b>		
> Operator's cabin alone		1,300 kg
<b>Weight Distribution During Transport, Machine with Standard Equipment</b>		
> Total transport weight	29,200 kg	29,350 kg
> Tongue weight on the towing device	7,750 kg	7,900 kg
> Total load of axle group	21,450 kg	21,450 kg
<b>Weight Distribution During Transport, Machine in Heaviest Configuration</b>		
> Total transport weight	31,000 kg	31,150 kg
> Tongue weight on the towing device	7,900 kg	8,050 kg
> Total load of axle group	23,100 kg	23,100 kg

<sup>1)</sup> Machine weight, half-full tanks, vehicle tool kit, excluding optional equipment

<sup>2)</sup> AdBlue® is a registered trademark of the German Association of the Automotive Industry (VDA)

## SIDE VIEW / TOP VIEW KMA 240(i)

## Machine in transport position

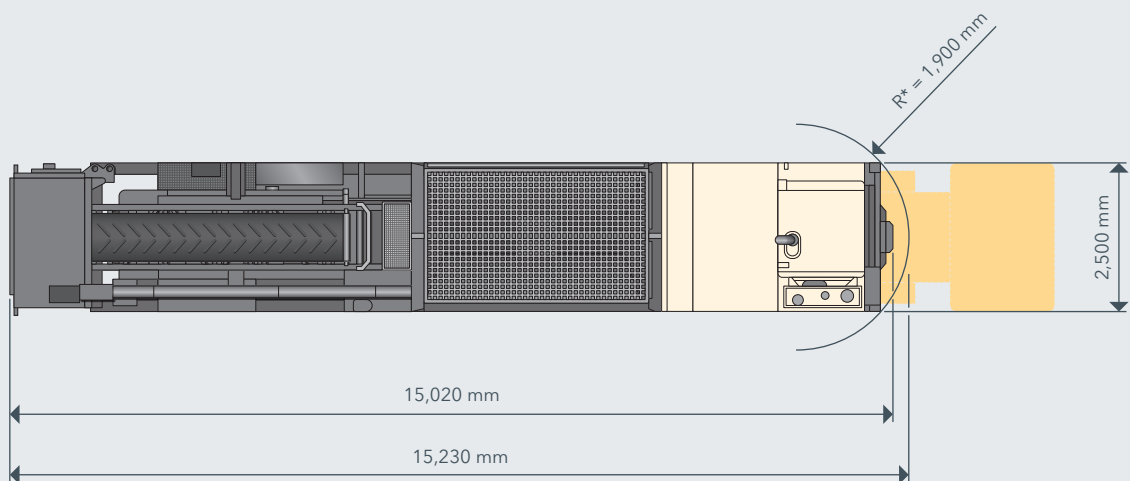
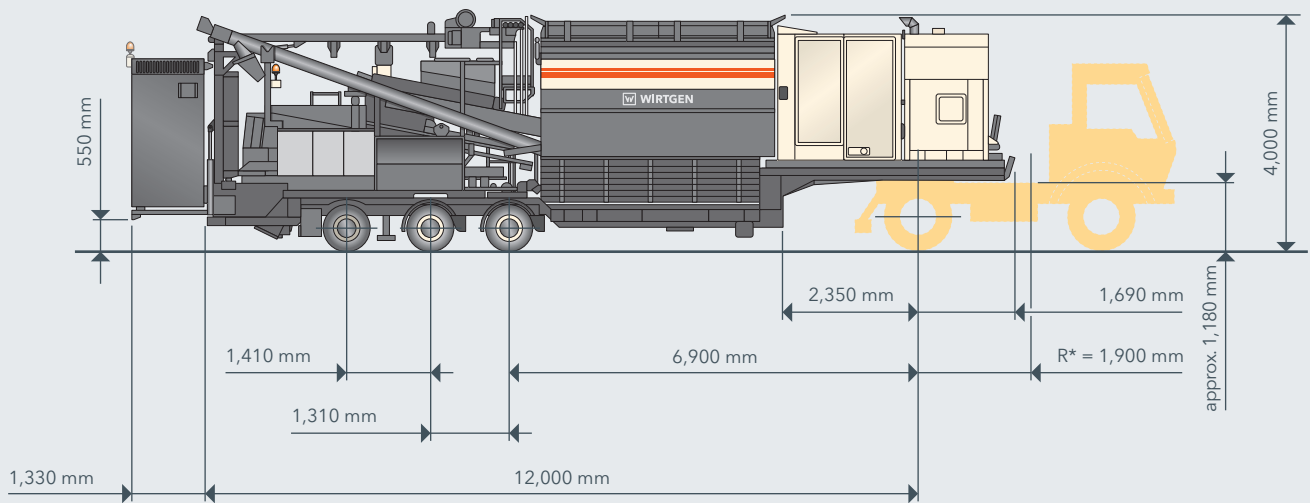

\* = Steering angle

STANDARD EQUIPMENT	KMA 240 (i)
<b>Basic machine</b>	
> Base machine with engine	■
> Mixing plant capacity of 240 t/h for producing cold mixes using granulated asphalt, recycled concrete granulate and/or new mineral aggregate mixtures	■
> Simple transport because the entire unit is mounted on a trailer	■
> Semi-trailer with three air suspension axles and an automatic, load-dependent dual-circuit air brake with EBS (electronic braking system)	■
> Registered according to European road transport directives	■
> Hydraulic and mechanical supports enable the mixing plant to be set up quickly and easily	■
> Large proportioning hopper, vertically divided to enable double-sided loading of two different raw materials with a capacity of 2 x 6 m <sup>3</sup> . The composition of the material is adjusted via sliders on the outlet of the proportioning hopper and monitored by laser scanners. When working with just one raw material, the entire 12 m <sup>3</sup> volume of the proportioning hopper can be made use of. The filling process can be carried out from both sides or just from one.	■
> Oversize granulate separation by shaker grids on the dosing unit for maximum granulate size of 45 mm. The grids can be folded up hydraulically for cleaning.	■
<b>Mixing Unit</b>	
> Integrated belt conveyor scales for continuous recording of the minerals	■
> Twin-shaft continuous mixer with wear lining ensures that the mix is processed homogeneously	■
> Adjustable metering gate for optimising the mixer filling level	■
<b>Spraying Unit / Binding Agent Addition</b>	
> Regulated feeding auger for hydraulic binding agents (cement/lime). Maximum feeding volume: 26 m <sup>3</sup> /h	■
> Connection for binder addition from a silo	■
> Double trough system to ensure that the hydraulic binding agent is accurately measured and dosed. The two trough auger conveyors are alternately weighed and emptied.	■
> A spraying system for adding water. Equipped with an eccentric auger pump (max. 200 l/min), flow-through meter and a spray bar.	■
> Automatic monitoring and regulation system for the predefined feeding quantities of binding agents and aggregates	■
> Load limitation regulator ensures optimum plant performance throughout the entire mixing and dosing process	■
> Locking parts in place of additional spraying units	□
<b>Operator's Platform</b>	
> Clearly arranged main control panel with a material flow diagram	■
> Multifunctional control colour display showing important process parameters	■
> Detailed machine diagnostics on the control display	■
> Detailed visualisation of job data and site-related logging	■
> In service mode, the individual drive and control units can be activated manually	■
> Operator's platform with cabin	■
<b>Miscellaneous</b>	
> Hydraulically swiveling loading conveyor for transport onto a stock-pile or for direct loading onto a truck	■
> The loading conveyor can be folded in hydraulically for transporting the plant	■
> Comprehensive LED lighting system for night operations	■
> Safety package with emergency stop switches	■

STANDARD EQUIPMENT		KMA 240 (i)
<b>Misceallaneous</b>		
> Tool box with extensive set of tools for maintenance and servicing		■
> Pre-fitting for installing the WITOS FleetView control unit		■
> Numerous, easily accessible storage spaces		■
> Standard painting in RAL 9001 (cream)		□
> WITOS - professional telematics solution for machine operation and service optimisation		□

- = Standard equipment  
 □ = Standard equipment, can be replaced with optional equipment if desired  
 □ = Optional equipment

OPTIONAL EQUIPMENT		KMA 240 (i)
<b>Spraying Unit / Binding Agent Addition</b>		
> Spraying system for bitumen emulsion		□
> Spraying system for foamed bitumen		□
> Loading hopper for loading the cement auger conveyor with cement bags		□
> Binder monitoring and aeration in the transfer silo		□
<b>Operator's Platform</b>		
> Air conditioner		□
> Cabin heater		□
> Printer for logging the job data		□
> USB interface for retrieving the job data		□
<b>Misceallaneous</b>		
> Painting in one special colour (RAL)		□
> Painting in two special colours (RAL)		□
> Model without WITOS		□
> Loading conveyor stripping-off brush		□
> Adjustable deflector plate on the discharge conveyor		□
> High-pressure water cleaner, 200 bar 20 l/min		□
> Diesel tank filling pump with suction hose		□
> Monitor system with 2 cameras, monitor and extra LED working lights		□
> Pre-fitting for LED lighting balloons		□
> LED lighting balloon, 24 volt		□
> Central lubrication unit for the mixer and the discharge conveyor		□
> Connection hose for water or bitumen emulsion		□
> Heated connection hose for hot bitumen		□

- = Standard equipment  
 □ = Standard equipment, can be replaced with optional equipment if desired  
 □ = Optional equipment

**WIRTGEN GmbH**

Reinhard-Wirtgen-Str. 2  
53578 Windhagen  
Germany

T: +49 2645 131-0  
F: +49 2645 131-392  
M: [info@wirtgen.com](mailto:info@wirtgen.com)

 [www.wirtgen.de](http://www.wirtgen.de)



For further information, please scan the code.